

W E R T H E R

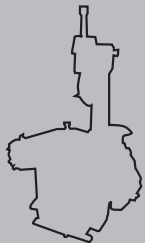
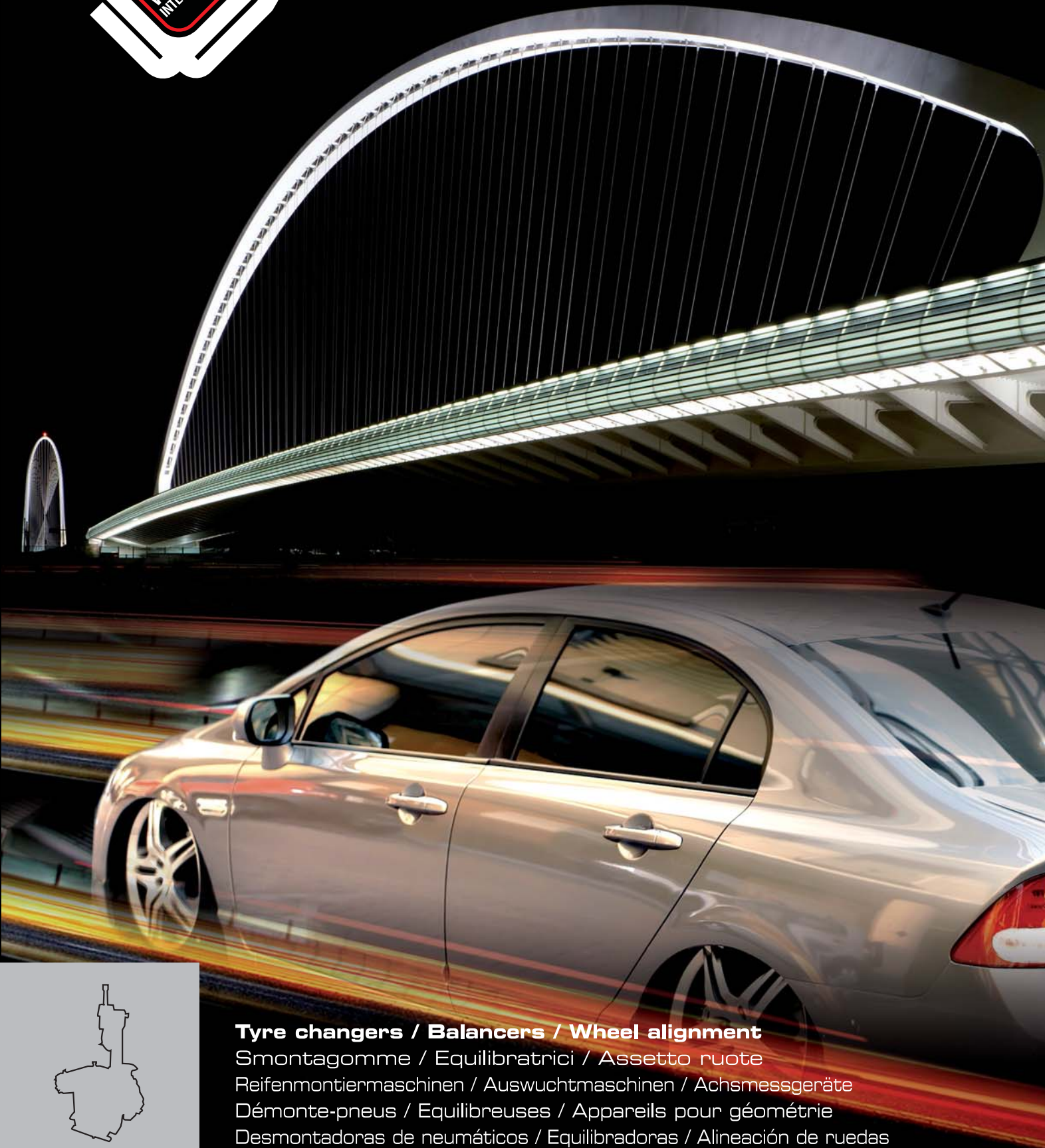

Tyre changers / Balancers / Wheel alignment

Smontagomme / Equilibratrici / Assetto ruote

Reifenmontiermaschinen / Auswuchtmaschinen / Achsmessgeräte

Démontepneus / Equilibreuses / Appareils pour géométrie

Desmontadoras de neumáticos / Equilibradoras / Alineación de ruedas



W E R T H E R

FTS Szerviztechnika Kft
H-1095 Budapest Soroksári út 150.
TEL: +36 1 95 22 000
Fax: +36 1 28 04 100
Mobil: +36 30 377 93 02
Email: info@fts.co.hu
WEB: www.fts.co.hu Kövesse weboldalunkat!
További információval szívesen állunk rendelkezésére.

 Regione Emilia-Romagna

Foto di copertina: Progetto Santiago Calatrava-Comune di Reggio E.-Foto Pdp



WERTHER INTERNATIONAL



HH LIONS UK
London, England



TECALEMIT UK
Plymouth, England

WERTHER BY NUMBERS

Founded by Mr. Enea Zanini and Mr. Werter Iori in 1970

- 12 company branches
- Total revenue: 145 million EURO
- 340 worldwide staff
- 42 year market presence
- Strategic worldwide locations
- 57 authorized distributors worldwide
- 89 authorized service centres
- Customers Support in 97 countries
- Major O.E.M supplies
- 23 production / commercial / warehouse sites
- 174.000 Sq.mt. of facilities
- 6 week lead-time from manufacturer to installation site

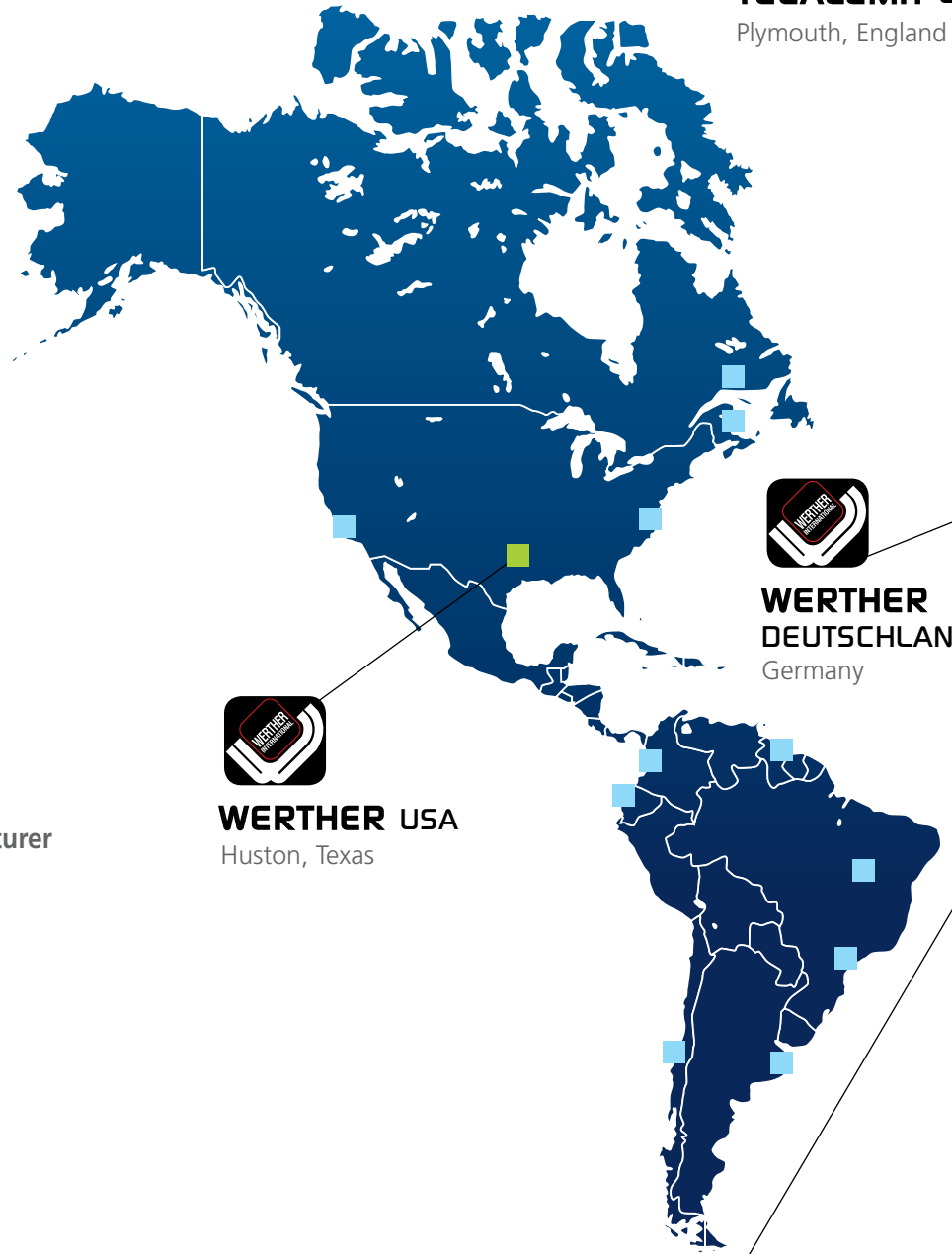

WERTHER DEUTSCHLAND
Germany



WERTHER USA
Huston, Texas



WERTHER IBERICA
Barcelona, Spain



Company Branches



Partners



Authorized Distributors



EGi FRANCE
Vierzon, France



Vierzon, France



INTERTECH
Copenhagen,
Denmark



WERATHER POLSKA
Poland



EGi POLAND
Poland

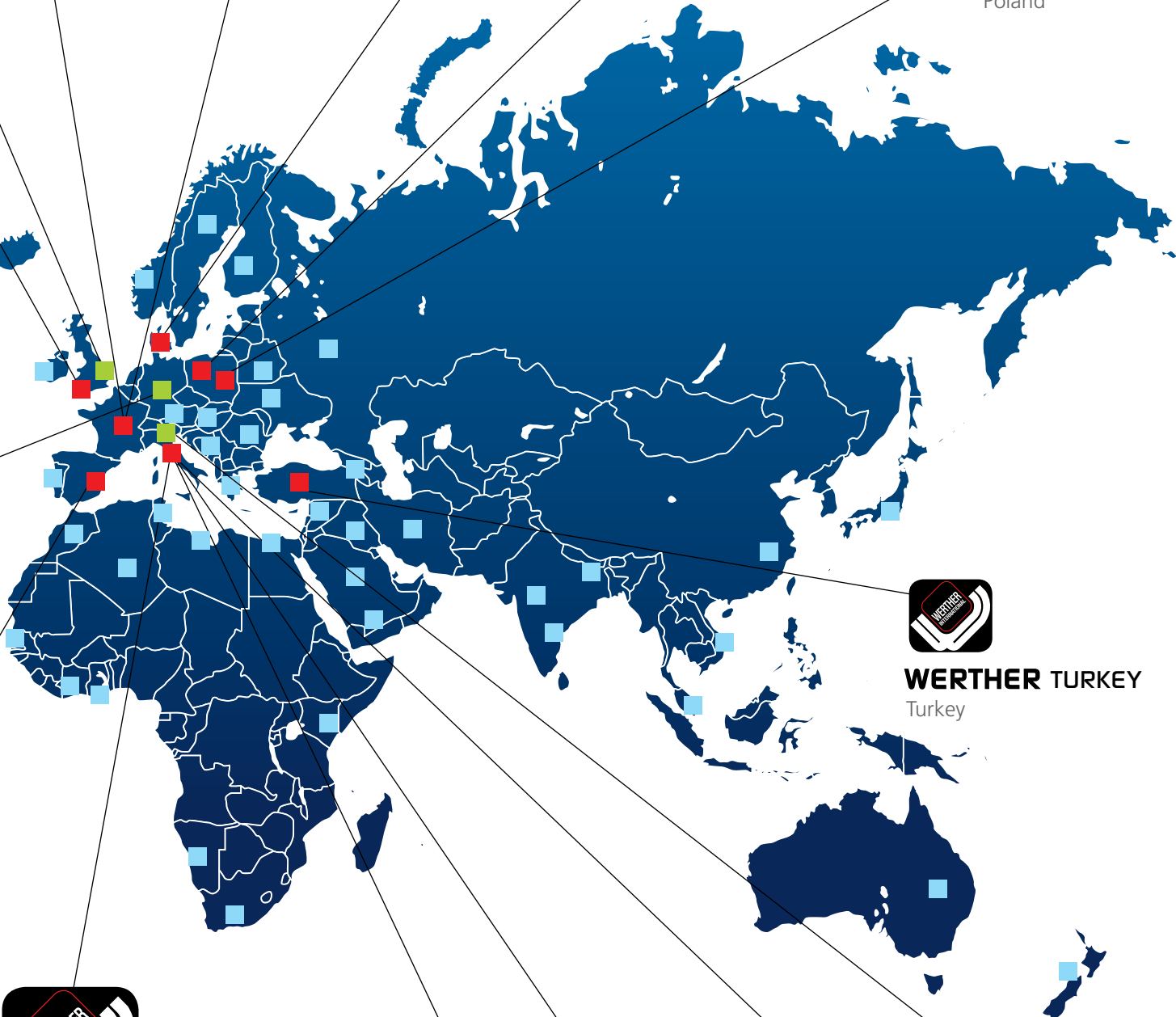

WERATHER TURKEY
Turkey



W E R T H E R

Via F. Brunelleschi, 12 - 42124 Cadè (RE) Italy
Tel. +39 0522 9431 +39 346 98 37 325 +39 346 98 37 443
Fax +39 0522 941997 e-mail: sales@wertherint.com

www.wertherint.com



Vicenza, Italy



Vicenza, Italy



Reggio Emilia, Italy



WT Engineering
Bergamo, Italy

The company reserves the right to introduce improvements in design or specification without prior notice

www.wertherint.com





TITANIUM 100/22

CE



 Smontagomme semiautomatico con braccio a bandiera per ruote di auto, moto e veicoli commerciali leggeri da 11" a 24".

 **Semi automatic tyre changer with swing arm for car, motorcycle and commercial vehicle wheels. Rim diameter 11" to 24".**

 Halbautomatische Reifenmontiermaschine mit Schwenkarm für Autos, Motorräder und leichte Nutzfahrzeuge mit 11" bis 24" Felgendurchmesser.

 Démonte pneus semi-automatique avec bras pivotant pour roues de voitures, motos et véhicules commerciaux légers de 11" à 24" de diamètre.

 Desmontadora de neumáticos con brazo en bandera para ruedas de turismos, motos y vehículos comerciales ligeros entre 11" y 24".

 • Autocentrante a due velocità di rotazione (6-12 giri/minuto) • Pistola di gonfiaggio • Limitatore pressione di gonfiaggio max. 3,5 Bar (50 PSI) • Leva alza tallone con protezione per cerchi in lega • Gruppo filtro • Serie protezione morsetti cerchi in lega • Anello e barattolo portagrasso • Pala stallonatrice con protezione per cerchi in lega.

 • Double speed turntable (6-12 rpm) • Inflating gun • Pressure limiting valve max 3,5 Bar (50 PSI) • Mounting lever with plastic protection for alloy rims • Filter regulator assy • Set of alloy rims protection • Ring bracket and grease pot • Bead breaker with plastic protection for alloy rims.

 • Drehtisch mit zwei Drehgeschwindigkeiten (6-12 UpM) • Reifenfüllvorrichtung • Kalibrierten Druckventil max 3,5 Bar (50 PSI) • Montierhebel mit Kunststoffschutz für Leichtmetallfelgen • Öler • Satz von Schutzkappen für Alufelgen • Ribghalter mit Fettkessel • Abdrückschaufel mit Kunststoffschutz für Leichtmetallfelgen.

 • Plateau à deux vitesses (6-12 tours/min.) • Pistolet de gonflage • Limiteur de pression de gonflage max 3,5 Bar (50 PSI) • Levier décolle-talon avec protection en plastique pour jantes en alliage • Groupe mano-détendeur • Jeu de protections jantes en alliage • Support pour seau à graisse • Décolleur avec protection en plastique pour jantes en alliage.

 • Plato de rotación con dos velocidades (6-12 rpm) • Pistola de inflado • Limitador de presión máximo 3,5 Bar (50 PSI) • Palanca sube-talón con protección para llantas de aleación • Grupo filtro • Juego de protecciones para llantas de aleación • Soporte y tarro portagrasa • Pala del destalonador con protección para llantas de aleación.

TITANIUM 100/22



Tavola autocentrante ottagonale
Octagonal self-centering turntable
Achteckiger Aufspanntisch
Table autcentreuse octogonale
Tablero autocentrante octagonal



Dati tecnici	Technical data	Technische Eigenschaften	Caractéristiques techniques	Datos técnico	
Bloccaggio cerchio dall'esterno	Rim clamping from outside	Aussenaufspannung der Felge	Serrage jante de l'extérieur	Bloqueo llanta por el exterior	11" - 22"
Bloccaggio cerchio dall'interno	Rim clamping from inside	Innenaufspannung der Felge	Serrage jante de l'intérieur	Bloqueo llanta por el interior	13" - 24"
Diametro max. ruota	Max. wheel diameter	Max. Raddurchmesser	Diamètre max. roue	Diámetro máx. rueda	1000 mm
Larghezza max. ruota	Max. wheel width	Max. Radbreite	Largeur max. roue	Anchura máx. rueda	295 mm
Forza cilindro stallonatore	Bead-breaking cylinder force	Kraft des Abdrückzylinders	Force du vérin détalonneur	Fuerza cilindro destalonador	30200 N (3080 Kg)
Pressione di servizio	Operating pressure	Betriebsdruck	Pression de service	Presión de servicio	8 - 10 bar
Alimentazione	Power supply	Versorgungsspannung	Alimentation	Alimentación	400V 50 Hz - 3 ph *
Potenza motore	Motor power	Motorleistung	Puissance moteur	Potencia motor	0,8 - 1,1 kW
Peso	Weight	Gewicht	Poids	Peso	190 Kg
Dimensioni	Dimension	Abmessungen	Encombrement	Medidas	995 x 760 x 950

* Optional 230 V 50 Hz - 3 ph

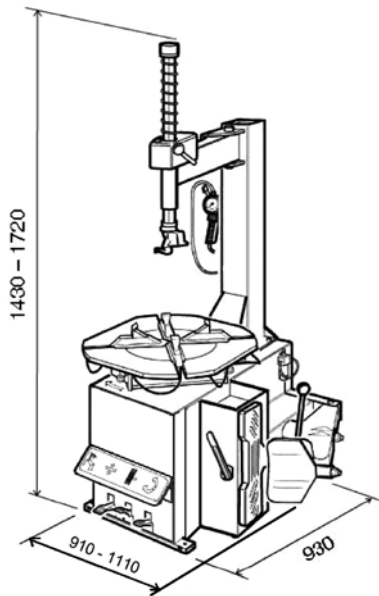

Opzioni



Optionals



Sonderzubehör



Options



Opciones



Kit cambio rapido utensile
Quick re-tooling kit
Schnellwechselsatz des Montage-/Demontagewerkzeugs
Kit accouplement rapide de l'outil de montage/démontage
Kit uñas de cambio rápido



Kit ruote motocicletta
Motorcycle adapter kit
Montagesatz f. Motorrad-Räder
Kit pour roues moto
Kit garas para motocicleta

Esecuzione con motore monofase (1 velocità)
Single-phase motor (single speed)
Ausführung mit Einphasenmotor (1 Geschwindigkeit)
Moteur monophasé (1 vitesse)
Motor monofásico (1 velocidad)

The company reserves the right to introduce improvements in design or specification without prior notice





TITANIUM 200/22

CE





 Smontagomme automatico con colonna ribaltabile pneumaticamente per ruote di auto, moto e veicoli commerciali leggeri da 11" a 24".

 **Automatic tyre changer with air operated tilting column for car, motorcycle and commercial wheels. Rim diameter 11" to 24".**

 Vollautomatische Reifenmontiermaschine mit pneumatisch kippbarer Säule für Autos, Motorräder und leichte Nutzfahrzeuge mit 11" bis 24" Felgendurchmesser.

 Démonte pneus automatique avec colonne basculante pneumatiquement pour roues de voitures, motos et véhicules commerciaux légers de 11" à 24" de diamètre.

 Desmontadora de neumáticos automática con columna abatible neumáticamente para ruedas de turismos, motos y vehículos comerciales ligeros entre 11" y 24".

 • Autocentrante a due velocità di rotazione (6-12 giri/minuto) • Pistola di gonfiaggio • Limitatore pressione di gonfiaggio max. 3,5 Bar (50 PSI) • Leva alza tallone con protezione per cerchi in lega • Gruppo filtro lubrificatore • Serie protezione morsetti cerchi in lega • Anello e barattolo portagrasso • Pala stallonatrice con protezione per cerchi in lega.

 • Double speed turntable (6-12 rpm) • Inflating gun • Pressure limiting valve max 3,5 Bar (50 PSI) • Mounting lever with plastic protection for alloy rims • Lubricator + filter regulator assy • Set of alloy rims protection • Ring bracket and grease pot • Bead breaker with plastic protection for alloy rims.

 • Drehtisch mit zwei Drehgeschwindigkeiten (6-12 UpM) • Reifenfüllvorrichtung • Kalibrierten Druckventil max 3,5 Bar (50 PSI) • Montierhebel mit Kunststoffschutz für Leichtmetallfelgen • Öler • Satz von Schutzkappen für Alufelgen • Ribghalter mit Fettkessel • Abdrückschaufel mit Kunststoffschutz für Leichtmetallfelgen.

 • Plateau à deux vitesses (6-12 tours/min.) • Pistolet de gonflage • Limiteur de pression de gonflage max 3,5 Bar (50 PSI) • Levier décolle-talon avec protection en plastique pour jantes en alliage • Groupe mano-détendeur • Jeu de protections jantes en alliage • Support pour seau à graisse • Décolleur avec protection en plastique pour jantes en alliage.

 • Plato de rotación con dos velocidades (6-12 rpm) • Pistola de inflado • Limitador de presión máximo 3,5 Bar (50 PSI) • Palanca sube-talón con protección para llantas de aleación • Grupo filtro lubricador • Juego de protecciones para llantas de aleación • Soporte y tarro portagrassa • Pala del destalonador con protección para llantas de aleación.

TITANIUM 200/22



Tavola autocentrante ottagonale
 Octagonal self-centering turntable
 Achteckiger Aufspanntisch
 Table autoceutreuse octogonale
 Tablero autocentrante octogonal



Dati tecnici	Technical data	Technische Eigenschaften	Caractéristiques techniques	Datos técnico	
Bloccaggio cerchio dall'esterno	Rim clamping from outside	Aussenaufspannung der Felge	Serrage jante de l'extérieur	Bloqueo llanta por el exterior	11" - 22"
Bloccaggio cerchio dall'interno	Rim clamping from inside	Innenaufspannung der Felge	Serrage jante de l'intérieur	Bloqueo llanta por el interior	13" - 24"
Diametro max. ruota	Max. wheel diameter	Max. Raddurchmesser	Diamètre max. roue	Diámetro máx. rueda	1000 mm
Larghezza max. ruota	Max. wheel width	Max. Radbreite	Largeur max. roue	Anchura máx. rueda	315 mm
Forza cilindro stallonatore	Bead-breaking cylinder force	Kraft des Abdrückzylinders	Force du vérin détalonneur	Fuerza cilindro destalonador	30200 N (3080 Kg)
Pressione di servizio	Operating pressure	Betriebsdruck	Pression de service	Presión de servicio	8 - 10 bar
Alimentazione	Power supply	Versorgungsspannung	Alimentation	Alimentación	400V 50 Hz - 3 ph *
Potenza motore	Motor power	Motorleistung	Puissance moteur	Potencia motor	0,8 - 1,1 kW
Peso	Weight	Gewicht	Poids	Peso	230 Kg
Dimensioni	Dimension	Abmessungen	Encombrement	Medidas	975 x 760 x 950

* Optional 230 V 50 Hz - 3 ph

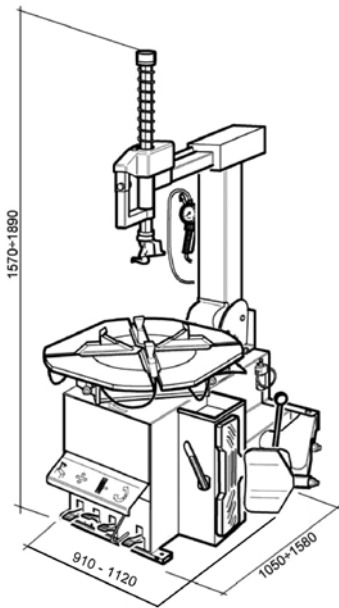

Opzioni



Optionals



Sonderzubehör



Options



Opciones



Kit cambio rapido utensile
 Quick re-tooling kit
 Schnellwechselsatz des Montage-/Demontagewerkzeugs
 Kit accouplement rapide de l'outil de montage/démontage
 Kit uñas de cambio rápido



Assistant H Titanium



Kit ruote motocicletta
 Motorcycle adapter kit
 Montagesatz f. Motorrad-Räder
 Kit pour roues moto
 Kit garas para motocicleta



Sollevatore ruote
 Wheel lift
 Radheber
 Élévateur de roue
 Elevador de ruedas

Esecuzione con motore monofase (1 velocità)
 Single-phase motor (single speed)
 Ausführung mit Einphasenmotor (1 Geschwindigkeit)
 Moteur monophasé (1 vitesse)
 Motor monofásico (1 velocidad)

The company reserves the right to introduce improvements in design or specification without prior notice





TITANIUM 300/24IT

CE



 Smontagomme automatico con colonna ribaltabile pneumaticamente per ruote di auto, moto e veicoli commerciali leggeri da 11" a 24".

 **Fully automatic tyre changer with air operated tilting column for car, motorcycle and commercial wheels. Rim diameter 11" to 24".**

 Vollautomatische Reifenmontiermaschine mit pneumatisch kippbarer Säule für Autos, Motorräder und leichte Nutzfahrzeuge mit 11" bis 24" Felgendurchmesser.

 Démonte pneus automatique avec colonne basculante pneumatiquement pour roues de voitures, motos et véhicules commerciaux légers de 11" à 24" de diamètre.

 Desmontadora de neumáticos automática con columna abatible neumáticamente para ruedas de turismos, motos y vehículos comerciales ligeros entre 11" y 24".

 • Autocentrante a due velocità di rotazione (6-12 giri/minuto) • Leva alza tallone con protezione per cerchi in lega • Gruppo filtro lubrificatore • Serie protezione morsetti cerchi in lega • Anello e barattolo portagrasso • Pala stallonatrice con protezione per cerchi in lega • Limitatore pressione di gonfiaggio max. 3,5 Bar (50 PSI) • Dispositivo di gonfiaggio INFLATOR.

 • Double speed turntable (6-12 rpm) • Mounting lever with plastic protection for alloy rims • Lubricator + filter regulator assy • Set of alloy rims protection • Ring bracket and grease pot • Bead breaker with plastic protection for alloy rims • Pressure limiting valve max 3,5 Bar (50 PSI) • INFLATOR tyres inflation system.

 • Drehtisch mit zwei Drehgeschwindigkeiten (6-12 UpM) • Montierhebel mit Kunststoffschutz für Leichtmetallfelgen • Öler • Satz von Schutzkappen für Alufelgen • Ribghalter mit Fettkessel • Abdrückschaufel mit Kunststoffschutz für Leichtmetallfelgen • Kalibrierten Druckventil max 3,5 Bar (50 PSI) • INFLATOR Schnelleinblasvorrichtung.

 • Plateau à deux vitesses (6-12 tours/min.) • Levier décolle-talon avec protection en plastique pour jantes en alliage • Groupe mano-détendeur • Jeu de protections jantes en alliage • Support pour seau à graisse • Décolleur avec protection en plastique pour jantes en alliage • Limiteur de pression de gonflage max 3,5 Bar (50 PSI) • Système gonflage INFLATOR.

 • Plato de rotación con dos velocidades (6-12 rpm) • Palanca sube-talón con protección para llantas de aleación • Grupo filtro lubricador • Juego de protecciones para llantas de aleación • Soporte y tarro portagrassa • Pala del destalonador con protección para llantas de aleación • Limitador de presión máximo 3,5 Bar (50 PSI) • Dispositivo de inflado INFLATOR.

TITANIUM 300/24IT



Tavola autocentrante ottagonale
Octagonal self-centering turntable
Achteckiger Aufspanntisch
Table autocentreuse octogonale
Tablero autocentrante octagonal



Dati tecnici	Technical data	Technische Eigenschaften	Caractéristiques techniques	Datos técnico	
Bloccaggio cerchio dall'esterno	Rim clamping from outside	Aussenaufspannung der Felge	Serrage jante de l'extérieur	Bloqueo llanta por el exterior	11" - 22"
Bloccaggio cerchio dall'interno	Rim clamping from inside	Innenaufspannung der Felge	Serrage jante de l'intérieur	Bloqueo llanta por el interior	13" - 24"
Diametro max. ruota	Max. wheel diameter	Max. Raddurchmesser	Diamètre max. roue	Diámetro máx. rueda	1000 mm
Larghezza max. ruota	Max. wheel width	Max. Radbreite	Largeur max. roue	Anchura máx. rueda	350 mm
Forza cilindro stallonatore	Bead-breaking cylinder force	Kraft des Abdrückzylinders	Force du vérin détalonneur	Fuerza cilindro destalonador	30200 N (3080 Kg)
Pressione di servizio	Operating pressure	Betriebsdruck	Pression de service	Presión de servicio	8 - 10 bar
Alimentazione	Power supply	Versorgungsspannung	Alimentation	Alimentación	400V 50 Hz - 3 ph *
Potenza motore	Motor power	Motorleistung	Puissance moteur	Potencia motor	0,75 kW
Rumorosità	Noise	Geräuschpegel	Niveau sonore	Ruido	70 dB(A) /1mt
Peso	Weight	Gewicht	Poids	Peso	279 Kg
Dimensioni	Dimension	Abmessungen	Encombrement	Medidas	1280 x 1750 x 1970

* Optional 230 50 Hz - 3 ph

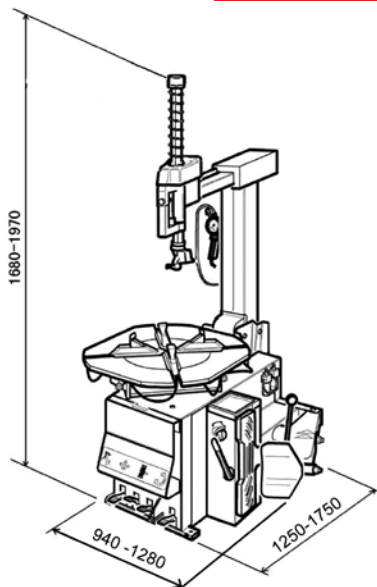

Opzioni



Optionals



Sonderzubehör



Options



Opciones



Kit cambio rapido utensile
Quick re-tooling kit
Schnellwechselsatz des Montage-/Demontagewerkzeugs
Kit accouplement rapide de l'outil de montage/démontage
Kit uñas de cambio rápido



Assistant H Titanium



Kit ruote motocicletta
Motorcycle adapter kit
Montagesatz f. Motorrad-Räder
Kit pour roues moto
Kit garas para motocicleta



Sollevatore ruote
Wheel lift
Radheber
Élévateur de roue
Elevador de ruedas

Esecuzione con motore monofase (1 velocità)
Single-phase motor (single speed)
Ausführung mit Einphasenmotor (1 Geschwindigkeit)
Moteur monophasé (1 vitesse)
Motor monofásico (1 velocidad)

The company reserves the right to introduce improvements in design or specification without prior notice



ASSISTANT H TITANIUM

CE



 Utensile alza/premi tallone per pneumatici ribassati.

 **Bead pressing/lifting tool for low profile tyres.**

 Reifenschulter-Hebe/Presswerkzeug für Niederquerschnittreifen.

 Outil lève/presse talon pour pneus à profil bas.

 Útil levanta/aprieta talón para neumáticos de perfil bajo

 Disponibile solo per Titanium 200/22 e Titanium 300/24 IT

 Only available for Titanium 200/22 and Titanium 300/24 IT

 Nur lieferbar für Titanium 200/22 und Titanium 300/24 IT

 Disponible seulement pour Titanium 200/22 et Titanium 300/24 IT

 Disponible sólo para Titanium 200/22 e Titanium 300/24 IT

ACCESSORI – ACCESSORIES – ZUBEHÖR – ACCESOIRES – ACCESORIOS

Codice Code Kenn-Nr Code Código.		Descrizione Description Beschreibung Description Descripción	TITANIUM 100/22	TITANIUM 200/22	TITANIUM 300/24
H 647		Assistant H Titanium Dispositivo alza/premi tallone per operare su pneumatici ribassati UHP e Run Flat. Assistant H Titanium Bead pressing/lifting tool for use with on Low-profile, UHP and Run-Flat tires. Assistant H Titanium Wulstheber/Wulstniederhalter für Niederquerschnittreifen UHP und Run Flat. Assistant H Titanium Dispositif lève/presse talon pour pneus à profil bas UHP et Run Flat Assistant H Titanium Dispositivo levanta/aprieta talón para actuar sobre neumáticos de perfil bajo UHP y Run Flat.	-	○	○
H649		Sollevatore ruote Wheel lift Radheber Élévateur roues Elevador ruedas	○	○	○
H910		Rulliera Roller unit Rollenbahn Convoyeur à rouleaux Grupo de rodillos	○	○	○
H915		Kit adattatori moto Motorcycle adapter kit Adapterkit für Motorräder Kit adaptateurs moto Kit adaptadores moto	○	○	○
H916		Kit cambio rapido utensile Quick re-tooling kit Werkzeugschnellwechselkit Kit changement rapide outil Kit cambio rápido de útil	○	○	○
A0624		Utensile in plastica Plastic tool Werkzeug aus Kunststoff Outil en plastique Util de plástico	○	○	○
H929		Inserto utensile (10 pcs) Tool insert (10 pcs) Werkzeugeinsatz (10 Stk) Élément outil (10 pièces) Inserto de útil (10 un.)	○	○	○
H930		Protezione utensile (10 pcs) Tool protector (10 pcs) Werkzeugschutz (10 Stk) Protection outil (10 pièces) Protección del útil (10 un.)	○	○	○
H931		Kit protezioni griffa per cerchi in lega (8 pcs) Kit of claw clamp protectors for alloy rims (8 pcs) Spannklauschutzkit für Leichtmetallfelgen (8 Stk) Kit protections griffe pour jantes en alliage (8 pièces) Kit protecciones garra para llantas de aleación (8 un.)	○	○	○
H932		Protezione leva alzatalone (4 pcs) Bead-lifting lever protector (4 pcs) Wulstheberhebelschutz (4 Stk) Protection levier détalonneur (4 pièces) Protección de palanca levanta talón (4 un.)	○	○	○
H933		Protezione paletta (4 pcs) Blade protector (4 pcs) Schaufelschutz (4 Stk) Protection palette (4 pièces) Protección de paleta (4 un.)	○	○	○

S Standard / ○ Optional / - Not available

The company reserves the right to introduce improvements in design or specification without prior notice



GEMINI 1522 PGS



Smontagomme automatico con colonna a ribaltamento pneumatico di nuova generazione ideale per operare su tutti i tipi di pneumatici (EMT, RFT, CRS, DSST, PAX etc) presenti sul mercato per auto, moto e veicoli commerciali leggeri da 10 a 23".



Automatic tire changer with pneumatically-operated tilting column of the latest generation, ideal for working on all types of tires (EMT, RFT, CRS, DSST, PAX, etc.) for cars, motorcycles and light commercial vehicles from 10" to 23".



Automatische Reifenmontiermaschine mit pneumatischer Kippsäule neuer Generation, ideal für alle auf dem Markt angebotenen Reifentypen für Kraftfahrzeuge, Motorräder und leichte Nutzfahrzeuge von 10 bis 23" (EMT, RFT, CRS, DSST, PAX usw.).



Démonte-pneus automatique à colonne de basculement pneumatique de nouvelle génération idéal pour opérer sur tous les types de pneus (EMT, RFT, CRS, DSST, PAX, etc.) disponibles sur le marché pour voitures, motos et véhicules commerciaux légers de 10 à 23".



Desmontadora automática de neumáticos con columna de volteo neumático de nueva generación, ideal para actuar sobre toda clase de neumáticos (EMT, RFT, CRS, DSST, PAX, etc.) entre 10" y 23" presentes en el mercado de automóviles, motos y vehículos comerciales ligeros.



	macchina base	Standard machine	Maschine in der Grundausführung	machine de base	máquina base
Gemini 1522	macchina base	Standard machine	Maschine in der Grundausführung	machine de base	máquina base
Gemini 1522 S	stallonatore speciale	Special bead-breaker	Spezial-Abdrückscheibe	détalonneur spécial	destalonador especial
Gemini 1522 PGS	gonfiaggio a pedale + stallonatore speciale	Pedal-operated inflation + special bead-breaker	Füllen des Reifens mittels Pedal + Spezialabdrückscheibe	gonflage à pédale + détalonneur spécial	inflado a pedal + destalonador especial
Gemini 1522 IT	dispositivo di gonfiaggio tubeless	Tubeless inflation device	Tubeless-Füllvorrichtung	dispositif de gonflage tubeless	dispositivo de inflado tubeless



• Autocentrante a due velocità di rotazione (7-14 giri/minuto) • Pistola di gonfiaggio • Limitatore pressione di gonfiaggio max 3,5 Bar (50 PSI) • Leva alza tallone con protezione per cerchi in lega • Gruppo filtro lubrificatore • Serie protezione morsetti cerchi in lega • Pala stallonatrice con protezione per cerchi in lega



• Self-centring chuck with two rotation speeds (7-14 rpm) • Inflation gun • Max. inflation pressure limiter 3.5 Bar (50 Psi) • Bead lifting lever with protector for alloy rims • Lubrication filter unit • Set of clamp protectors for alloy rims • Bead-breaker blade with protector for alloy rims.



• Selbstzentrierend mit zwei Drehgeschwindigkeiten (7-14 Drehungen/Minute) • Füllpistole - Fülldruckbegrenzer max. 3,5 bar (50 PSI) • Wulstheberhebel mit Schutz für Leichtmetallfelgen • Filter-Schmierer-Gruppe • Klammerschutzsatz für Leichtmetallfelgen • Abdrückschaufel mit Schutz für Leichtmetallfelgen



• Serrage concentrique à deux vitesses de rotation (7-14 tours par minute) • Pistolet de gonflage • Limiteur pression de gonflage max. 3,5 bars (50 PSI) • Levier lève-talon avec protection pour jantes en alliage • Groupe filtre graisseur • Série protection mâchoires jantes en alliage • Pale détalonneur avec protection pour jantes en alliage



• Autocentrante con dos velocidades de rotación (7-14 rpm) • Pistola de inflado • Limitador de presión de inflado máx. 3,5 Bar (50PSI) • Palanca levanta talón con protección para llantas de aleación • Grupo filtro lubricador • Serie protección de garras para llantas de aleación • Pala destalonadora con protección para llantas de aleación

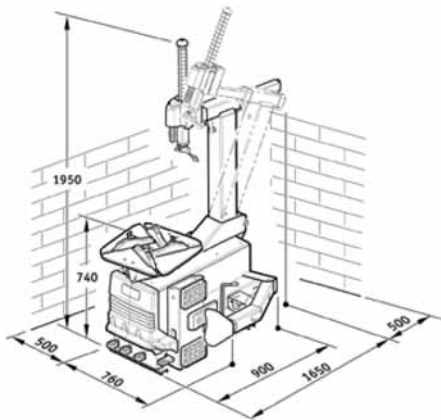

Standard version



S version



La robustezza e la forma dello stallonatore rende queste macchine particolarmente adatte ad operare con ruote di grandi dimensioni (oltre 13" di larghezza). Le versioni S sono dotate di uno speciale dispositivo che permette di variare la misura di apertura della paletta con estrema facilità.

The ruggedness and the conformation of the bead-breaker make these machines particularly suitable for working on large wheels (over 13" in width). The S version has a special device to adjust the opening of the blade with utmost simplicity.

Die Widerstandsfähigkeit und die Form des Wulstabdrückers tragen dazu bei, dass diese Maschinen besonders für die Bearbeitung großer Reifen (Breite über 13") geeignet sind. Die S-Ausführungen sind mit einer speziellen Vorrichtung ausgestattet, die es ermöglicht, außerordentlich leicht die Öffnungsweite der Schaufel zu verändern.

Grâce à la robustesse et à la forme du détalonneur, ces machines sont particulièrement adaptées pour opérer avec des roues de grandes dimensions (plus de 13" de largeur). Les versions S sont équipées d'un dispositif spécial qui permet de varier l'ouverture de la palette avec une grande facilité.

La robustez y la forma del destalonador hacen sí que estas máquinas sean especialmente idóneas para actuar con ruedas grandes (más de 13" de anchura). Las versiones S equipan un dispositivo especial que permite modificar muy fácilmente la medida de apertura de la paleta.



IT version

Il dispositivo di gonfiaggio IT può essere incorporato, a richiesta, su tutte le macchine. Si compone di un circuito supplementare di aria che ha un passaggio diretto agli orifizi di ogni corsia, favorendo l'intallamento di qualsiasi tipo di pneumatico. Il dispositivo di gonfiaggio PG è dotato di uno strumento di controllo fisso a scala graduata con comando a pedale (standard nella versione IT).

The IT inflation device can be installed on all machines. It consists of a supplementary air circuit with passage directly to the orifices of each lane, making it easier to fit the bead on any type of tire. The PG inflation device is equipped with a fixed control instrument with graduated scale and pedal command (standard in the version IT).

Die Füllvorrichtung IT kann auf Anfrage in alle Maschinen eingebaut werden. Sie besteht aus einem zusätzlichen Luftkreis mit Direktdurchgang zu den Öffnungen aller Führungen, was das Einsetzen der Reifenwulste jedes Reifentyps erleichtert. Die Füllvorrichtung PG ist mit einem fest angebrachten Messgerät mit Gradskala und Pedalsteuerung ausgestattet (Standard bei der IT-Ausführung).

Le dispositif de gonflage IT peut être incorporé, sur demande, dans toutes les machines. Il comprend un circuit d'air supplémentaire qui offre un passage direct aux orifices de chaque course, favorisant ainsi le montage de tout type de pneu. Le dispositif de gonflage PG est équipé d'un outil de contrôle fixe à échelle graduée avec une commande à pédale (standard dans la version IT).

En todas las máquinas se puede incorporar, bajo pedido, el dispositivo de inflado IT. Se compone de un circuito suplementario del aire que tiene un pasaje directo a los agujeros en cada pista, facilitando el entalonado de todo tipo de neumático. El dispositivo de inflado PG está equipado con un instrumento fijo de control con escala graduada y mando a pedal (estándar en la versión IT).



PG version

Dati tecnici	Technical data	Technische Eigenschaften	Caractéristiques techniques	Datos técnico	
Bloccaggio cerchio dall'esterno	Rim clamping from outside	Aussenaufspannung der Felge	Serrage jante de l'extérieur	Bloqueo llanta por el exterior	10" - 20"
Bloccaggio cerchio dall'interno	Rim clamping from inside	Innenaufspannung der Felge	Serrage jante de l'intérieur	Bloqueo llanta por el interior	12" - 23"
Diametro max. ruota	Max. wheel diameter	Max. Raddurchmesser	Diamètre max. roue	Diámetro máx. rueda	1160 mm
Larghezza max. ruota	Max. wheel width	Max. Radbreite	Largeur max. roue	Anchura máx. rueda	406 mm (16")
Forza cilindro stallonatore	Bead-breaking cylinder force	Kraft des Abdrückzylinders	Force du vérin détalonneur	Fuerza cilindro destalonador	25500 N (2500 Kg)
Pressione di servizio	Operating pressure	Betriebsdruck	Pression de service	Presión de servicio	8 - 12 bar
Alimentazione	Power supply	Versorgungsspannung	Alimentation	Alimentación	400V 50 Hz - 3 ph*
Potenza motore	Motor power	Motorleistung	Puissance moteur	Potencia motor	1,2 - 0,9 kW
Peso	Weight	Gewicht	Poids	Peso	220 kg - 238 kg
Rumorosità	Noise	Geräuschpegel	Niveau sonore	Ruido	70 dB(A)/1 mt
Dimensioni	Dimension	Abmessungen	Encombrement	Medidas	760 x 1070 x 1130

* Optional 230 V 50 Hz - 3 ph

Opzioni Optionals Sonderzubehör Options Opciones

Vedere tabella specifica - Refer to specific table - Siehe spezifische Tabelle - Voir tableau correspondant - Véase la tabla específica

The company reserves the right to introduce improvements in design or specification without prior notice



GEMINI 1528 PG



Smontagomme automatico con colonna a ribaltamento pneumatico di nuova generazione ideale per operare su tutti i tipi di pneumatici (EMT, RFT, CRS, DSST, PAX etc) presenti sul mercato per auto, moto e veicoli commerciali leggeri da 10 a 31".

Automatic tire changer with pneumatically-operated tilting column of the latest generation, ideal for working on all types of tires (EMT, RFT, CRS, DSST, PAX etc.) for cars, motorcycles and light commercial vehicles from 10" to 31".

Automatische Reifenmontiermaschine mit pneumatischer Kippsäule neuer Generation, ideal für alle auf dem Markt angebotenen Reifentypen für Kraftfahrzeuge, Motorräder und leichte Nutzfahrzeuge von 10 bis 31" (EMT, RFT, CRS, DSST, PAX usw.).

Démonte-pneus automatique à colonne de basculement pneumatique de nouvelle génération idéal pour opérer sur tous les types de pneus (EMT, RFT, CRS, DSST, PAX, etc.) disponibles sur le marché pour voitures, motos et véhicules commerciaux légers de 10 à 31".

Desmontadora automática de neumáticos con columna de volteo neumático de nueva generación, ideal para actuar sobre toda clase de neumáticos (EMT, RFT, CRS, DSST, PAX, etc.) entre 10" y 31" presentes en el mercado de automóviles, motos y vehículos comerciales ligeros.



Gemini 1528	macchina base	Standard machine	Maschine in der Grundausführung	machine de base	máquina base
Gemini 1528 PG	gonfiaggio a pedale	Pedal-operated inflation	Füllen des Reifens mittels Pedals	gonflage à pédale	inflado a pedal
Gemini 1528 IT	dispositivo di gonfiaggio tubeless	Tubeless inflation device	Tubeless-Füllvorrichtung	dispositif de gonflage tubeless	dispositivo de inflado tubeless

• Autocentrante a due velocità di rotazione (7-14 giri/minuto) • Pistola di gonfiaggio • Limitatore pressione di gonfiaggio max 3,5 Bar (50 PSI) • Leva alza tallone con protezione per cerchi in lega • Gruppo filtro lubrificatore • Serie protezione morsetti cerchi in lega • Pala stallonatrice con protezione per cerchi in lega

• Self-centring chuck with two rotation speeds (7-14 rpm) • Inflation gun • Max. inflation pressure limiter 3.5 Bar (50 Psi) • Bead lifting lever with protector for alloy rims • Lubrication filter unit • Set of clamp protectors for alloy rims • Bead-breaker blade with protector for alloy rims.

• Selbstzentrierend mit zwei Drehgeschwindigkeiten (7-14 Drehungen/Minute) • Füllpistole • Fülldruckbegrenzer max. 3,5 bar (50 PSI) • Wulstheberhebel mit Schutz für Leichtmetallfelgen • Filter-Schmierer-Gruppe • Klammerschutzsatz für Leichtmetallfelgen • Abdrückschaufel mit Schutz für Leichtmetallfelgen

• Serrage concentrique à deux vitesses de rotation (7-14 tours par minute) • Pistolet de gonflage • Limiteur pression de gonflage max. 3,5 bars (50 PSI) • Levier lève-talon avec protection pour jantes en alliage • Groupe filtre graisseur • Série protection mâchoires jantes en alliage • Pale détalonneur avec protection pour jantes en alliage

• Autocentrante con dos velocidades de rotación (7-14 rpm) • Pistola de inflado • Limitador de presión de inflado máx. 3,5 Bar (50PSI) • Palanca levanta talón con protección para llantas de aleación • Grupo filtro lubricador • Serie protección de garras para llantas de aleación • Pala destalonadora con protección para llantas de aleación

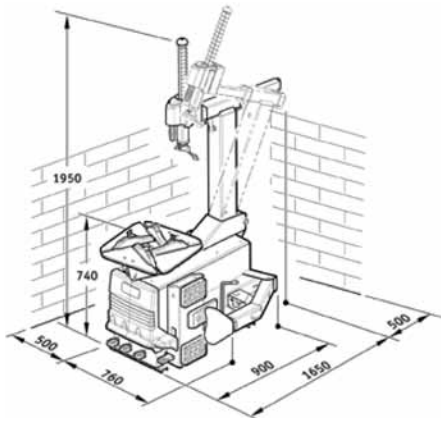

- Lo smontagomme è dotato di serie di griffe di bloccaggio dal design innovativo con range di serraggio da 10" a 28" per cerchi in alluminio, e da 12" a 31" per cerchi in acciaio. Di serie questo smontagomme utilizza sempre lo stallonatore sfilabile di tipo S.
- The tire changer features some innovative clamping claws with a clamping range from 10" to 28" for aluminium rims, and from 12" to 31" for steel rims. In the standard version, this tire changer always utilises the removable bead-breaker type S.
- Die Reifenmontiermaschine ist serienmäßig mit einer Reihe Spannklaue innovativen Designs ausgestattet und ist für das Aufspannen von Leichtmetallfelgen zu 10" bis 28" und von Stahlfelgen zu 12" bis 31" geeignet. Diese Reifenmontiermaschinen sind serienmäßig mit dem ausziehbaren Wulstabdrücker Typ S ausgestattet.
- Le démonte-pneus standard est équipé de griffes de blocage au design innovant avec une plage de serrage de 10" à 28" pour les jantes en aluminium, et de 12" à 31" pour les jantes en acier. Le démonte-pneus standard est toujours équipé d'un détalonneur amovible de type S.
- La desmontadora de neumáticos está equipada de serie con garras bloqueadoras de diseño innovador, con un rango de apriete entre 10" y 28" para llantas de aluminio y entre 12" y 31" para llantas de acero. Di serie esta desmontadora utiliza siempre el destalonador extraíble de tipo S.



IT version



PG version

- Il dispositivo di gonfiaggio IT può essere incorporato, a richiesta, su tutte le macchine. Si compone di un circuito supplementare di aria che ha un passaggio diretto agli orifici di ogni corsia, favorendo l'intallamento di qualsiasi tipo di pneumatico. Il dispositivo di gonfiaggio PG è dotato di uno strumento di controllo fisso a scala graduata con comando a pedale (standard nella versione IT).
- The IT inflation device can be built into all the machines, on request. It consists of a supplementary air circuit with passage directly to the orifices of each lane, making it easier to fit the bead on any type of tire. The PG inflation device is equipped with a fixed control instrument with graduated scale and pedal command (standard in IT version).
- Die Füllvorrichtung IT kann auf Anfrage in alle Maschinen eingebaut werden. Sie besteht aus einem zusätzlichen Luftkreis mit Direktdurchgang zu den Öffnungen aller Führungen, was das Einsetzen der Reifenwulste jedes Reifentyps erleichtert. Die Füllvorrichtung PG ist mit einem fest angebrachten Messgerät mit Gradskala und Pedalsteuerung ausgestattet (Standard bei der IT-Ausführung).
- Le dispositif de gonflage IT peut être incorporé, sur demande, dans toutes les machines. Il comprend un circuit d'air supplémentaire qui offre un passage direct aux orifices de chaque course, favorisant ainsi le montage de tout type de pneu. Le dispositif de gonflage PG est équipé d'un outil de contrôle fixe à échelle graduée avec une commande à pédale (standard dans la version IT).
- En todas las máquinas se puede incorporar, bajo pedido, el dispositivo de inflado IT. Se compone de un circuito suplementario del aire que tiene un pasaje directo a los agujeros en cada pista, facilitando el entalonado de todo tipo de neumático. El dispositivo de inflado PG está equipado con un instrumento fijo de control con escala graduada y mando a pedal (estándar en la versión IT).

Dati tecnici	Technical data	Technische Eigenschaften	Caractéristiques techniques	Datos técnico
Bloccaggio cerchio dall'esterno	Rim clamping from outside	Aussenaufspannung der Felge	Serrage jante de l'extérieur	Bloqueo llanta por el exterior 10" - 28"
Bloccaggio cerchio dall'interno	Rim clamping from inside	Innenaufspannung der Felge	Serrage jante de l'intérieur	Bloqueo llanta por el interior 12" - 31"
Diametro max. ruota	Max. wheel diameter	Max. Raddurchmesser	Diamètre max. roue	Diámetro máx. rueda 1160 mm
Larghezza max. ruota	Max. wheel width	Max. Radbreite	Largeur max. roue	Anchura máx. rueda 406 mm (16")
Forza cilindro stallonatore	Bead-breaking cylinder force	Kraft des Abdrückzylinders	Force du vérin détalonneur	Fuerza cilindro destalonador 25500 N (2500 Kg)
Pressione di servizio	Operating pressure	Betriebsdruck	Pression de service	Presión de servicio 8 - 12 bar
Alimentazione	Power supply	Versorgungsspannung	Alimentation	Alimentación 400V 50 Hz - 3 ph*
Potenza motore	Motor power	Motorleistung	Puissance moteur	Potencia motor 1,2 - 0,9 kW
Peso	Weight	Gewicht	Poids	Peso 220 kg - 238 kg
Rumorosità	Noise	Geräuschpegel	Niveau sonore	Ruido 70 dB(A)/1 mt
Dimensioni	Dimension	Abmessungen	Encombrement	Medidas 760 x 1070 x 1130

* Optional 230 V 50 Hz - 3 ph

Opzioni Optionals Sonderzubehör Options Opciones

Vedere tabella specifica - Refer to specific table - Siehe spezifische Tabelle - Voir tableau correspondant - Véase la tabla específica



**GEMINI 1522 LL PGS
+ TECNOARM
+ HELPER GROUP**



Smontagomme automatico leverless con colonna a ribaltamento pneumatico di nuova generazione ideale per operare su tutti i tipi di pneumatici (EMT, RFT, CRS, DSST, PAX etc) presenti sul mercato per auto, moto e veicoli commerciali leggeri da 10 a 23”.



Automatic leverless tire changer with pneumatically-operated tilting column of the latest generation, ideal for working on types of tires (EMT, RFT, CRS, DSST, PAX etc.) for cars, motorcycles and light commercial vehicles from 10” to 23”.



Automatische Leverless-Reifenmontiermaschine mit pneumatischer Kippsäule neuer Generation, ideal für alle auf dem Markt angebotenen Reifentypen für Kraftfahrzeuge, Motorräder und leichte Nutzfahrzeuge von 10 bis 23” (EMT, RFT, CRS, DSST, PAX usw.).



Démonte-pneus automatique leverless à colonne de basculement pneumatique de nouvelle génération idéal pour opérer sur tous les types de pneus (EMT, RFT, CRS, DSST, PAX, etc.) disponibles sur le marché pour voitures, motos et véhicules commerciaux légers de 10 à 23”.



Desmontadora de neumáticos sin palanca con columna de volteo neumático de nueva generación, ideal para actuar sobre toda clase de neumáticos (EMT, RFT, CRS, DSST, PAX, etc.) entre 10” y 23” presentes en el mercado de automóviles, motos y vehículos comerciales ligeros.



	macchina base	Standard machine	Maschine in der Grundausführung	machine de base	máquina base
Gemini 1522 LL S	stallonatore speciale	Special bead-breaker	Spezial-Wulstabdrücker	détalonneur spécial	destalonador especial
Gemini 1522 LL PG S	gonfiaggio a pedale + stallonatore speciale	Pedal-operated inflation + special bead-breaker	Füllen des Reifens mittels Pedals + Spezial-Wulstabdrücker	gonflage à pédale + détalonneur spécial	inflado a pedal + destalonador especial
Gemini 1522 LL IT	dispositivo di gonfiaggio tubeless	Tubeless inflation device	Tubeless-Füllvorrichtung	dispositif de gonflage tubeless	dispositivo de inflado tubeless

• Autocentrante a due velocità di rotazione (7-14 giri/minuto) • Pistola di gonfiaggio • Limitatore pressione di gonfiaggio max 3,5 Bar (50 PSI) • Gruppo filtro lubrificatore • Serie protezione morsetti cerchi in lega • Pala stallonatrice con protezione per cerchi in lega

• Self-centring chuck with two rotation speeds (7-14 rpm) • Inflation gun • Max. inflation pressure limiter 3.5 Bar (50 Psi) • Lubrication filter unit • Set of clamp protectors for alloy rims • Bead-breaker blade with protector for alloy rims.

• Selbstzentrierend mit zwei Drehgeschwindigkeiten (7-14 Drehungen/Minute) • Füllpistole • Fülldruckbegrenzer max. 3,5 bar (50 PSI) • Filter-Schmierer-Gruppe • Klammerschutzsatz für Leichtmetallfelgen • Abdrückschaufel mit Schutz für Leichtmetallfelgen

• Serrage concentrique à deux vitesses de rotation (7-14 tours par minute) • Pistolet de gonflage • Limiteur pression de gonflage max. 3,5 bars (50 PSI) • Groupe filtre graisseur • Série protection mâchoires jantes en alliage • Pale détalonneur avec protection pour jantes en alliage

• Autocentrante con dos velocidades de rotación (7-14 rpm) • Pistola de inflado • Limitador de presión de inflado máx. 3,5 Bar (50PSI) • Grupo filtro lubricador • Serie protección de garras para llantas de aleación • Pala destalonadora con protección para llantas de aleación

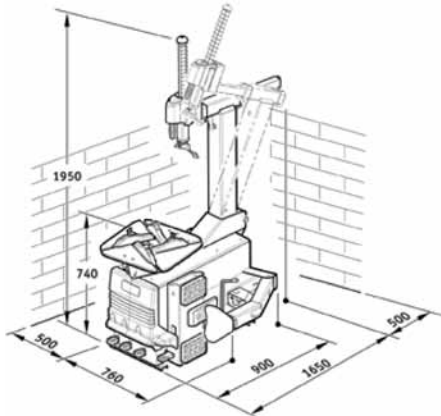

- Il sistema LL, (Patent) può essere applicato su tutta la gamma degli smontagomme automatici mantenendo inalterate le caratteristiche di base delle macchine. Il sistema LL rivoluziona il concetto di lavoro sul pneumatico e sulla ruota in generale. Risolve in modo semplice e totale le problematiche legate alle ruote di ultima generazione: Run-flat, Low-profile e grandi dimensioni senza danneggiare cerchi e pneumatici.
- The patented LL system may be fitted on the whole range of Gemini automatic tire changers, maintaining the standard characteristics of the machine unaltered. It revolutionises the concept of working on tires and wheels in general. It simply and totally resolves problems related to modern wheels: Run-flat, Low-profile and large wheels without damaging rims and tires.
- Das LL-System (Patent) kann an allen von uns angebotenen automatischen Reifenmontiermaschinen angebracht werden, verändert nicht die Grundeigenschaften der Maschinen und revolutioniert die Bearbeitung von Reifen und Rädern im Allgemeinen. Es löst auf einfache Art und Weise alle mit den Reifen jüngster Generation - Run-Flat, Low-profile und große Reifen - verbundenen Probleme, ohne Felgen oder Reifen zu beschädigen.
- Le système LL (Patent) peut être appliqué sur toute la gamme des démonte-pneus automatiques, sans altérer les caractéristiques de base des machines. Il résout de manière simple et totale les problèmes liés aux roues de dernière génération : Run Flat, Low Profile et de grandes dimensions, sans endommager les jantes et les pneus.
- El sistema LL (Patentado) se puede aplicar en toda la gama de desmontadoras automáticas sin cambiar las características básicas de las máquinas. El sistema LL revoluciona el concepto de trabajo con el neumático y con la rueda en general. Soluciona de una manera simple y total los problemas relacionados con las ruedas de última generación: Run-flat, Low-profile y grandes medidas, sin dañar ni las llantas ni los neumáticos.

Dati tecnici	Technical data	Technische Eigenschaften	Caractéristiques techniques	Datos técnico	
Bloccaggio cerchio dall'esterno	Rim clamping from outside	Aussenaufspannung der Felge	Serrage jante de l'extérieur	Bloqueo llanta por el exterior	10" - 20"
Bloccaggio cerchio dall'interno	Rim clamping from inside	Innenaufspannung der Felge	Serrage jante de l'intérieur	Bloqueo llanta por el interior	12" - 23"
Diametro max. ruota	Max. wheel diameter	Max. Raddurchmesser	Diamètre max. roue	Diámetro máx. rueda	1160 mm
Larghezza max. ruota	Max. wheel width	Max. Radbreite	Largeur max. roue	Anchura máx. rueda	406 mm (16")
Forza cilindro stallonatore	Bead-breaking cylinder force	Kraft des Abdrückzylinders	Force du vérin déballonneur	Fuerza cilindro destalonador	25500 N (2500 Kg)
Pressione di servizio	Operating pressure	Betriebsdruck	Pression de service	Presión de servicio	8 - 12 bar
Alimentazione	Power supply	Versorgungsspannung	Alimentation	Alimentación	400V 50 Hz - 3 ph*
Potenza motore	Motor power	Motorleistung	Puissance moteur	Potencia motor	1,2 - 0,9 kW
Peso	Weight	Gewicht	Poids	Peso	220 kg - 238 kg
Rumorosità	Noise	Geräuschpegel	Niveau sonore	Ruido	70 dB(A)/1 mt
Dimensioni	Dimension	Abmessungen	Encombrement	Medidas	760 x 1070 x 1130

* Optional 230 V 50 Hz - 3 ph / Motoinverter 230 V 50 Hz 1 ph

Opzioni
 Optionals
 Sonderzubehör
 Options
 Opciones

Vedere tabella specifica - Refer to specific table - Siehe spezifische Tabelle - Voir tableau correspondant - Véase la tabla específica

The company reserves the right to introduce improvements in design or specification without prior notice



GEMINI 1528 LL – 1528 LL PG – 1528 LL IT



GEMINI 1528 LL IT
+ TECNOARM
+ HELPER GROUP



Smontagomme automatico con colonna a ribaltamento pneumatico di nuova generazione ideale per operare su tutti i tipi di pneumatici (EMT, RFT, CRS, DSST, PAX etc) presenti sul mercato per auto, moto e veicoli commerciali leggeri da 10 a 31".



Automatic tire changer with pneumatically-operated tilting column of the latest generation, ideal for working on all types of tires (EMT, RFT, CRS, DSST, PAX etc.) for cars, motorcycles and light commercial vehicles from 10" to 31".



Automatische Reifenmontiermaschine mit pneumatischer Kippsäule neuer Generation, ideal für alle auf dem Markt angebotenen Reifentypen für Kraftfahrzeuge, Motorräder und leichte Nutzfahrzeuge von 10 bis 31" (EMT, RFT, CRS, DSST, PAX usw.).



Démonte-pneus automatique à colonne de basculement pneumatique de nouvelle génération idéal pour opérer sur tous les types de pneus (EMT, RFT, CRS, DSST, PAX, etc.) disponibles sur le marché pour voitures, motos et véhicules commerciaux légers de 10 à 31".



Desmontadora automática de neumáticos con columna de volteo neumático de nueva generación, ideal para actuar sobre toda clase de neumáticos (EMT, RFT, CRS, DSST, PAX, etc.) entre 10" y 31" presentes en el mercado de automóviles, motos y vehículos comerciales ligeros.



Gemini 1528 LL

macchina base

Standard machine

Maschine in der Grundausführung

machine de base

máquina base

Gemini 1528 LL PG

gonfiaggio a pedale

Pedal-operated inflation

Füllen des Reifens mittels Pedals

gonflage à pédale

inflado a pedal

Gemini 1528 LL IT

dispositivo di gonfiaggio tubeless

Tubeless inflation device

Tubeless-Füllvorrichtung

dispositif de gonflage tubeless

dispositivo de inflado tubeless



• Autocentrante a due velocità di rotazione (7-14 giri/minuto) • Pistola di gonfiaggio • Limitatore pressione di gonfiaggio max 3,5 Bar (50 PSI) • Gruppo filtro lubrificatore • Serie protezione morsetti cerchi in lega • Pala stallonatrice con protezione per cerchi in lega



• Self-centring chuck with two rotation speeds (7-14 rpm) • Inflation gun • Max. inflation pressure limiter 3.5 Bar (50 Psi) • Lubrication filter unit • Set of clamp protectors for alloy rims • Bead-breaker blade with protector for alloy rims.



• Selbstzentrierend mit zwei Drehgeschwindigkeiten (7-14 Drehungen/Minute) • Füllpistole • Fülldruckbegrenzer max. 3,5 bar (50 PSI) • Filter-Schmierer-Gruppe • Klammerschutzsatz für Leichtmetallfelgen • Abdrückschaufel mit Schutz für Leichtmetallfelgen



• Serrage concentrique à deux vitesses de rotation (7-14 tours par minute) • Pistolet de gonflage • Limiteur pression de gonflage max. 3,5 bars (50 PSI) • Groupe filtre graisseur • Série protection mâchoires jantes en alliage • Pale détalonneur avec protection pour jantes en alliage



• Autocentrante con dos velocidades de rotación (7-14 rpm) • Pistola de inflado • Limitador de presión de inflado máx. 3,5 Bar (50PSI) • Grupo filtro lubricador • Serie protección de garras para llantas de aleación • Pala destalonadora con protección para llantas de aleación

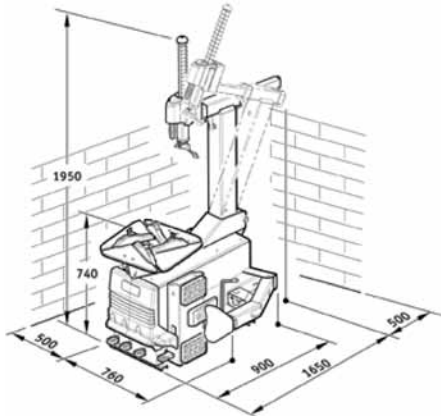

- Il sistema LL, (Patent) può essere applicato su tutta la gamma degli smontagomme automatici mantenendo inalterate le caratteristiche di base delle macchine. Il sistema LL rivoluziona il concetto di lavoro sul pneumatico e sulla ruota in generale. Risolve in modo semplice e totale le problematiche legate alle ruote di ultima generazione: Run-flat, Low-profile e grandi dimensioni senza danneggiare cerchi e pneumatici.
- The patented LL system may be fitted on the whole range of Gemini automatic tire changers, maintaining the standard characteristics of the machine unaltered. It revolutionises the concept of working on tires and wheels in general. It simply and totally resolves problems related to modern wheels: Run-flat, Low-profile and large wheels without damaging rims and tires.
- Das LL-System (Patent) kann an allen von uns angebotenen automatischen Reifenmontiermaschinen angebracht werden, verändert nicht die Grundeigenschaften der Maschinen und revolutioniert die Bearbeitung von Reifen und Rädern im Allgemeinen. Es löst auf einfache Art und Weise alle mit den Reifen jüngster Generation - Run-Flat, Low-profile und große Reifen - verbundenen Probleme, ohne Felgen oder Reifen zu beschädigen.
- Le système LL (Patent) peut être appliqué sur toute la gamme des démonte-pneus automatiques, sans altérer les caractéristiques de base des machines. Il résout de manière simple et totale les problèmes liés aux roues de dernière génération : Run Flat, Low Profile et de grandes dimensions, sans endommager les jantes et les pneus.
- El sistema LL (Patentado) se puede aplicar en toda la gama de desmontadoras automáticas sin cambiar las características básicas de las máquinas. El sistema LL revoluciona el concepto de trabajo con el neumático y con la rueda en general. Soluciona de una manera simple y total los problemas relacionados con las ruedas de última generación: Run-flat, Low-profile y grandes medidas, sin dañar ni las llantas ni los neumáticos.

Dati tecnici	Technical data	Technische Eigenschaften	Caractéristiques techniques	Datos técnico	
Bloccaggio cerchio dall'esterno	Rim clamping from outside	Serrage jante de l'extérieur	Aussenauflassung der Felge	Bloqueo llanta por el exterior	10" - 28"
Bloccaggio cerchio dall'interno	Rim clamping from inside	Serrage jante de l'intérieur	Innenaufspannung der Felge	Bloqueo llanta por el interior	12" - 31"
Diametro max. ruota	Max. wheel diameter	Diamètre max. roue	Max. Raddurchmesser	Diámetro máx. rueda	1160 mm
Larghezza max. ruota	Max. wheel width	Largeur max. roue	Max. Radbreite	Anchura máx. rueda	406 mm (16")
Forza cilindro stallonatore	Bead-breaking cylinder force	Force du vérin détalonneur	Kraft des Abdrückzylinders	Fuerza cilindro destalonador	25500 N (2500 Kg)
Pressione di servizio	Operating pressure	Pression de service	Betriebsdruck	Presión de servicio	8 - 12 bar
Alimentazione	Power supply	Alimentation	Versorgungsspannung	Alimentación	400V 50 Hz - 3 ph*
Potenza motore	Motor power	Puissance moteur	Motorleistung	Potencia motor	1,2 - 0,9 kW
Peso	Weight	Poids	Gewicht	Peso	220 kg - 238 kg
Rumorosità	Noise	Niveau sonore	Geräuschpegel	Ruido	70 dB(A)/1 mt
Dimensioni	Dimension	Encombrement	Abmessungen	Medidas	760 x 1070 x 1130

* Optional 230 V 50 Hz - 3 ph / Motoinverter 230 V 50 Hz 1 ph

Opzioni
 Optionals
 Sonderzubehör
 Options
 Opciones

Vedere tabella specifica - Refer to specific table - Voir tableau correspondant - Siehe spezifische Tabelle - Véase la tabla específica





GEMINI 1555 SL





GEMINI 1555 SL
+ WHEEL LIFT
+ HELPER GROUP





 Smontagomme superautomatico leverless con colonna a ribaltamento pneumatico di nuova generazione ideale per operare su tutti i tipi di pneumatici (EMT, RFT, CRS, DSST, PAX etc) presenti sul mercato per auto, moto e veicoli commerciali leggeri da 10 a 30".

 **Super automatic leverless tire changer with pneumatically-operated tilting column of the latest generation, ideal for working on all types of tires (EMT, RFT, CRS, DSST, PAX etc.) for cars, motorcycles and light commercial vehicles from 10" to 30".**

 Superautomatische Leverless-Reifenmontiermaschine mit pneumatischer Kippsäule neuer Generation, ideal für alle auf dem Markt angebotenen Reifentypen für Kraftfahrzeuge, Motorräder und leichte Nutzfahrzeuge von 10 bis 30" (EMT, RFT, CRS, DSST, PAX usw.).

 Démonte-pneus super automatique leverless à colonne de basculement pneumatique de nouvelle génération idéal pour opérer sur tous les types de pneus (EMT, RFT, CRS, DSST, PAX, etc.) disponibles sur le marché pour voitures, motos et véhicules commerciaux légers de 10 a 30".

 Desmontadora superautomática de neumáticos sin palanca con columna de volteo neumático de nueva generación, ideal para actuar sobre toda clase de neumáticos (EMT, RFT, CRS, DSST, PAX, etc.) entre 10" y 30" presentes en el mercado de automóviles, motos y vehículos comerciales ligeros.

 • Autocentrante a platorello a due velocità di rotazione (7-14 giri/minuto) • Limitatore pressione di gonfiaggio max 3,5 Bar (50 PSI) • Dispositivo di gonfiaggio a pedale con unità di lettura. Sistema LL (brevettato). Stallonatore laterale a paletta. Pressore/stallonatore verticale a dischi • Gruppo filtro lubrificatore • Serie completa di protezioni in plastica per cerchi in lega

 • Self-centring chuck with backing plate and two rotation speeds (7-14 rpm) • Max. inflation pressure limiter 3.5 Bar (50 Psi) • Pedal-operated inflation device with reading unit • Patented LL system • Side bead-breaker with blade. Vertical disc bead-breaker/presser • Lubrication filter unit • Set of plastic protectors for alloy rims.

 • Selbstzentrierender Teller mit 2 Drehgeschwindigkeiten (7-14 Drehungen/Minute) • Fülldruckbegrenzer max. 3,5 bar (50 PSI) • Pedalfüllvorrichtung mit Anzeigeeinheit. LL-System (patentiert). Seitliche Abdrückschaufel. Vertikaler Wulstniederhalter/Wulstabdrücker mit Scheiben • Filter-Schmierer-Gruppe • Kompletter Satzschutz aus Kunststoff für Leichtmetallfelgen

 • Serrage à disque à deux vitesses de rotation (7-14 tours par minute) • Limiteur pression de gonflage max. 3,5 bars (50 PSI) • Dispositif de gonflage à pédale avec unité de lecture Système LL (breveté). • Détalonneur latéral à palette. Disque presseur/détalonneur vertical à disques • Groupe filtre graisseur • Série complète de protections en plastique pour jantes en alliage

 • Autocentrante con platillo con dos velocidades de rotación (7-14 rpm) • Limitador de presión de inflado máx. 3,5 Bar (50 PSI) • Dispositivo de inflado a pedal con unidad de lectura. Sistema LL (patentado). Destalonador lateral con paleta. Prensador/destalonador vertical con discos • Grupo filtro lubricador • Serie completa de protecciones de plástico para llantas de aleación



Il sistema LL (Patent) applicato su tutta la gamma degli smontagomme automatici mantiene inalterate le caratteristiche di base delle macchine. Rivoluziona il concetto di lavoro sul pneumatico e sulla ruota in generale. Risolve in modo semplice e totale le problematiche legate alle ruote di ultima generazione: Run-flat, Low-profile e grandi dimensioni senza danneggiare cerchi e pneumatici.

The patented LL system fitted on the whole range of Gemini automatic tire changers maintains the standard characteristics of the machine unaltered. It revolutionises the concept of working on tires and wheels in general. It simply and totally resolves problems related to modern wheels: Run-flat, Low-profile and large wheels without damaging rims and tires.

Das an allen unseren automatischen Reifenmontiermaschinen angebrachte LL-System (Patent) verändert nicht die Grundeigenschaften der Maschinen und revolutioniert die Bearbeitung von Reifen und Rädern im Allgemeinen. Es löst auf einfache Art und Weise alle mit den Reifen jüngster Generation - Run-Flat, Low-profile und große Reifen - verbundenen Probleme, ohne Felgen oder Reifen zu beschädigen.

Le système LL (Patent) appliqué sur toute la gamme des démonte-pneus automatiques permet de ne pas altérer les caractéristiques de base des machines. Il révolutionne le concept de travail sur le pneu et sur la roue en général. Il résout de manière simple et totale les problèmes liés aux roues de dernière génération : Run Flat, Low Profile et de grandes dimensions, sans endommager les jantes et les pneus.

El sistema LL (Patentado) aplicado en toda la gama de desmontadoras automáticas no cambia las características básicas de las máquinas. Revoluciona el concepto de trabajo con el neumático y con la rueda en general. Soluciona de una manera simple y total los problemas relacionados con las ruedas de última generación: Run-flat, Low-profile y grandes medidas, sin dañar ni las llantas ni los neumáticos.



Dati tecnici	Technical data	Technische Eigenschaften	Caractéristiques techniques	Datos técnico	
Bloccaggio cerchio	Rim clamping from Rim	Aussenaufspannung	Serrage jante	Bloqueo llanta	10" - 30"
Diametro max. ruota	Max. wheel diameter	Max. Raddurchmesser	Diamètre max. roue	Diámetro máx. rueda	1160 mm (46")
Larghezza max. ruota	Max. wheel width	Max. Radbreite	Largeur max. roue	Anchura máx. rueda	mm (16")
Forza cilindro stallonatore	Bead-breaking cylinder force	Kraft des Abdrückzylinders	Force du vérin détalonneur	Fuerza cilindro destalonador	25500 N (2500 Kg)
Pressione di servizio	Operating pressure	Betriebsdruck	Pression de service	Presión de servicio	8 - 12 bar
Alimentazione	Power supply	Versorgungsspannung	Alimentation	Alimentación	400V 50 Hz - 3 ph*
Potenza motore	Motor power	Motorleistung	Puissance moteur	Potencia motor	1,2 - 0,9 kW
Peso	Weight	Gewicht	Poids	Peso	380 kg
Rumorosità	Noise	Geräuschpegel	Niveau sonore	Ruido	70 dB(A)/1 mt
Dimensioni	Dimension	Abmessungen	Encombrement	Medidas	1260 x 1040 x 1980

* Optional 230 V 50 Hz - 3 ph / Motoinverter 230 V 50 Hz 1 ph

Opzioni Optionals Sonderzubehör Options Opciones

Vedere tabella specifica - Refer to specific table - Voir tableau correspondant - Siehe spezifische Tabelle - Véase la tabla específica

The company reserves the right to introduce improvements in design or specification without prior notice

CE





 Utensile alza/premi tallone per pneumatici ribassati.

 **Bead pressing/lifting tool for low profile tyres.**

 Reifenschulter-Hebe/Presswerkzeug für Niederquerschnittreifen.

 Outil lève/presse talon pour pneus à profil bas.

 Útil levanta/aprieta talón para neumáticos de perfil bajo.

 Gruppo Helper per Tecnoarm dispositivo supplementare per Tecnoarm facilita le procedure di montaggio e smontaggio dei pneumatici UHP, Run Flat low profile

 **The supplementary Helper device for the Tecnoarm makes it easier to mount and demount UHP, Run-Flat and Low-profile tires.**





 Helper-Einheit für Tecnoarm, die zusätzliche Vorrichtung für Tecnoarm, erleichtert das Auf- und Abziehen von UHP-, Run Flat- und Niederquerschnittreifen.





 Groupe Helper pour Tecnoarm dispositif supplémentaire pour Tecnoarm, facilite le montage et le démontage des pneus UHP, Run Flat et Low Profile.

 Grupo Helper para Tecnoarm, dispositivo suplementario para Tecnoarm, facilita las operaciones de montaje y desmontaje de los neumáticos UHP, Run Flat y Low-profile









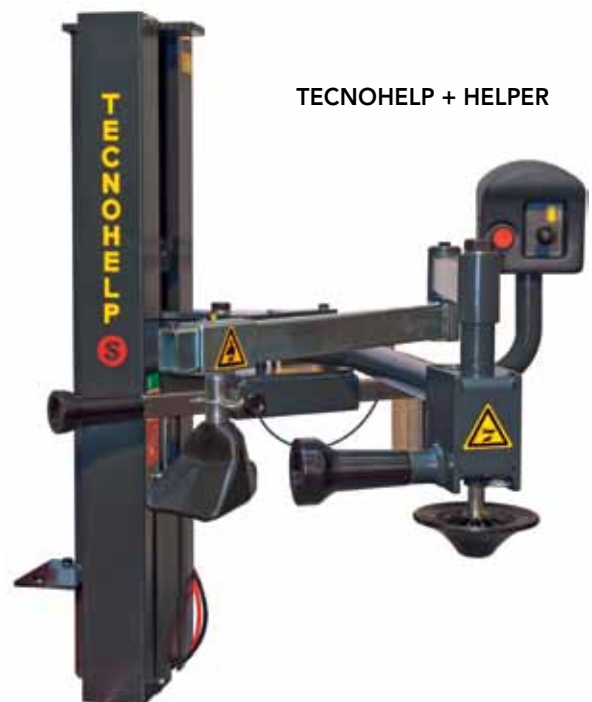



-  Utensile alza/premi tallone per pneumatici ribassati.
-  **Bead pressing/lifting tool for low profile tyres.**
-  Reifenschulter-Hebe/Presswerkzeug für Niederquerschnittreifen.
-  Outil lève/presse talon pour pneus à profil bas.
-  Útil levanta/aprieta talón para neumáticos de perfil bajo.

-  Per facilitare le procedure di montaggio e smontaggio dei pneumatici UHP, Run Flat low profile può essere applicato al Tecnohelp il dispositivo Helper.
-  **To make it easier to mount and demount UHP, Run-Flat and Low-Profile tires, the Helper device can be fitted on the Tecnohelp unit.**
-  Für ein leichteres Auf- und Abziehen von UHP-, Run Flat- und Niederquerschnittreifen kann die Helper-Vorrichtung am Tecnohelp angebracht werden.
-  Pour faciliter le montage et le démontage des pneus UHP, Run Flat et Low Profile, le dispositif Helper peut être appliqué au Tecnohelp.
-  Para facilitar las operaciones de montaje y desmontaje de los neumáticos UHP, Run-flat y Low-profile, se puede aplicar el dispositivo Helper al Tecnohelp



ACCESSORI – ACCESSORIES – ZUBEHÖR – ACCESSOIRES – ACCESORIOS

Codice Code Kenn-Nr Code Código.		Descrizione Description Beschreibung Description Descripción	1522	1522 S	1522 PGS	1522 IT	1522 LL	1522 LL S	1522 LL PGS	1522 LL IT	1528	1528 PG	1528 IT	1528 LL	1528 LL PG	1528 LL IT	555 SL
H934		Leva alza tallone Bead lever Hebel zur Wulstanhebung Levier lève-talon Palanca alza talones	S	S	S	S	S	S	S	S	S	S	S	S	S	S	S
H673		Tecnohelp Utensile alza/premi tallone per pneumatici ribassati. Bead pressing/lifting tool for low profile tyres. Reifenschulter-Hebe/Presswerkzeug für Niederquerschnittreifen. Outil lève/presse talon pour pneus à profil bas. Útil levanta/aprieta talón para neumáticos de perfil bajo.	O	O	O	O	O	O	O	O	O	O	O	O	O	O	-
H676		Helper per Tecnohelp Supplementary Helper device for the Tecnohelp Helper-Einheit für Tecnohelp Groupe Helper pour Tecnohelp Grupo Helper para Tecnohelp	O	O	O	O	O	O	O	O	O	O	O	O	O	O	-
H672		Tecnoarm Utensile alza/premi tallone per pneumatici ribassati. Bead pressing/lifting tool for low profile tyres. Reifenschulter-Hebe/Presswerkzeug für Niederquerschnittreifen. Outil lève/presse talon pour pneus à profil bas. Útil levanta/aprieta talón para neumáticos de perfil bajo.	O	O	O	O	O	O	O	O	O	O	O	O	O	O	-
H677		Gruppo helper per Tecnoarm Supplementary Helper device for the Tecnoarm Helper-Einheit für Tecnoarm Groupe Helper pour Tecnoarm Grupo Helper para Tecnoarm	O	O	O	O	O	O	O	O	O	O	O	O	O	O	-
V089		Pistola di gonfiaggio Inflation gun Aufblaspistole Pistolets de gonflage Pistola de hinchado	S	S	S	-	S	S	S	-	S	S	-	S	S	-	-
H682		Sistema gonfia - tubeless Tubeless inflation system System für schlauchlose Reifen Système de gonflage des pneus tubeless. Sistema de inflado tubeless.	O	O	O	S	O	O	O	S	O	O	S	O	O	S	-
H668		Sistema gonfia - tubeless Tubeless inflation system System für schlauchlose Reifen Système de gonflage des pneus tubeless. Sistema de inflado tubeless.	-	-	-	-	-	-	-	-	-	-	-	-	-	-	O
H697		Sollevatore ruote Wheel lift Radheber Élévateur roues Elevador ruedas	O	O	O	O	O	O	O	O	O	O	O	O	O	O	-
H680		Sollevatore ruote Wheel lift Radheber Élévateur roues Elevador ruedas	-	-	-	-	-	-	-	-	-	-	-	-	-	-	O
H699		Attacco scooter Scooter wheel adaptor Halter für Scooter Kit scooter Kit garras scooter	O	O	O	O	O	O	O	O	O	O	O	O	O	O	-
H698		Attacco motocicletta Motorbike wheel adaptor Motorradhalter kit moto kit garras moto	O	O	O	O	O	O	O	O	O	O	O	O	O	O	-
H910		Rulliera Roller unit Rollenbahn Convoyeur à rouleaux Grupo de rodillos	O	O	O	O	O	O	O	O	O	O	O	O	O	O	-
H686		Inserito utensile Tool insert Werkzeugeinsatz Elément outil Inserito de útil	O	O	O	O	-	-	-	-	O	O	O	-	-	-	-

S Standard / O Optional / - Not available

ACCESSORI – ACCESSORIES – ZUBEHÖR – ACCESSOIRES – ACCESORIOS

Codice Code Kenn-Nr Code Código.		Descrizione Description Beschreibung Description Descripción	1522	1522 S	1522 PGS	1522 IT	1522 LL	1522 LL S	1522 LL PGS	1522 LL IT	1528	1528 PG	1528 IT	1528 LL	1528 LL PG	1528 LL IT	555 SL
H694		Inserto utensile Tool insert Werkzeugeinsatz Élément outil Inserto de útil	-	-	-	-	O	O	O	-	-	-	-	O	O	O	O
H687		Protezione utensile Tool protector Werkzeugschutz Protection outil Protección del útil	O	O	O	O	-	-	-	-	O	O	O	-	-	-	-
H695		Protezione utensile Tool protector Werkzeugschutz Protection outil Protección del útil	-	-	-	-	O	O	O	-	-	-	-	O	O	O	O
H688		Kit protezioni griffa per cerchi in lega Kit of claw clamp protectors for alloy rims Spannklauenschutzkit für Leichtmetallfelgen Kit protections griffe pour jantes en alliage Kit protecciones garra para llantas de aleación	O	O	O	O	O	O	O	O	O	O	O	O	O	O	O
H689		Protezione paletta Blade protector Schaufelschutz Protection palette Protección de paleta	O	O	O	O	O	O	O	O	O	O	O	O	O	O	O
H692		Protezione bordo cerchio. Rim-edge protection Kunststoffschutz für Felgen Protection bord de jante Protección borde de la llanta	O	O	O	O	O	O	O	O	O	O	O	O	O	O	O
H691		Leva alza tallone UHP / Run flat Bead lever UHP / Run flat Hebel zur Wulstanhebung UHP / Run flat Lévier lève-talon UHP / Run flat Palanca alza talones UHP / Run flat	O	O	O	O	O	O	O	O	O	O	O	O	O	O	O
H690		Protezione leva alzatalone Bead-lifting lever protector Wulstheberhebelschutz Protection levier détalonneur Protección de palanca levanta talón	O	O	O	O	O	O	O	O	O	O	O	O	O	O	O
H935		Morsetto RFT RFT bead clamp RFT Klemme Pince – étau RFT Mordaza RFT	O	O	O	O	O	O	O	O	O	O	O	O	O	O	O
H684		Flangia per cerchi a canale rovesciato e senza foro centrale. Flange for reversed well rims without central hole. Flansch für "umgekehrte" Tiefbettfelgen und solche ohne Mittelloch. Bride pour jantes à gorge retournée et sans trou central. Brida para llantas de canal invertido y sin orificio central.	-	-	-	-	-	-	-	-	-	-	-	-	-	-	O
H683		Distanziale Spacer Abstandhalter Entretoise Espaciador	-	-	-	-	-	-	-	-	-	-	-	-	-	-	O
H936		Protezione plastica platorello Plastic protection for self-centering chuck Kunststoffschutz für Spindel Protection plastique pour mandrin universel Protección de plástico para plato autocentrante	-	-	-	-	-	-	-	-	-	-	-	-	-	-	S





S Standard / O Optional / - Not available

The company reserves the right to introduce improvements in design or specification without prior notice







TITANIUM 1000

CE





-  Smontagomme elettroidraulico per rapido smontaggio e montaggio pneumatici con e senza camera d'aria di autocarri, autobus e veicoli industriali, con cerchi a canale e ad anello elastico.
-  **Easy demounting and mounting electro-hydraulic tyre changer for trucks, buses and industrial vehicles tubed or tubeless, with groove rim and split ring rim.**
-  Elektrohydraulische Reifenmontiermaschine für schlauchlose und Schlauchreifen für Lkw, Busse und Nutzfahrzeuge, mit Tiefbett- oder Sprengingfelgen.
-  Démonte-pneus électro-hydraulique pour camion pour le montage et le démontage de roues de camions, bus et véhicules industriels avec ou sans chambre à air, avec jante à rainure ou à bague fendue.
-  Desmontadora electrohidráulica para desmontaje y montaje rapido de neumáticos de camiones, autobuses y vehiculos industriales, con y sin cámara de aire, para llantas canal o llantas con anillo elástico.



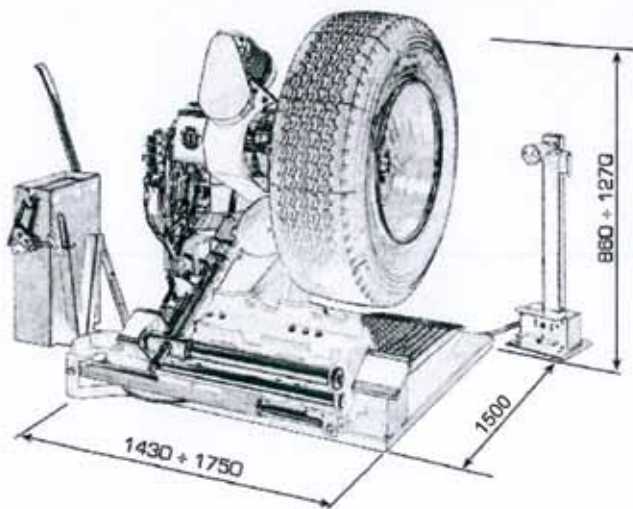



-  • Mandrino autocentrante a due velocità di rotazione (6 - 12 giri/minuto). • Per pneumatici tube e tubeless da 13" a 27".
-  • Double speed self-centring chuck (6 - 12 rpm). • For tube and tubeless-type tyres from 13" to 27" diameters.
-  • Selbstzentrierendes Universal-Spannfutter mit zwei Drehgeschwindigkeiten (6 - 12 UpM). • Für Reifen mit oder ohne Schlauch von 13" bis 27" Durchmesser.
-  • Mandrin universel à deux vitesses (6 - 12 tours/min.). • Pour pneus avec chambre air et tubeless de 13" à 27" de diamètre.
-  • Autocentrante con dos velocidades (6 - 12 rpm). • Para neumáticos tube y tubeless entre 13" y 27".





TITANIUM 1000



-  Carrello con movimento idraulico e braccio utensili con traslazione manuale
-  Hydraulically operated carriage, tool holder arm with manual traverse
-  Schlitten mit hydraulischem Antrieb und Montagewerkzeug mit manueller Verfahrsteuerung
-  Chariot à mouvement hydraulique et bras porte-outils à translation manuelle
-  Carro con movimiento hidráulico y brazo para herramientas con traducción manual



-  Unità di controllo portatile
-  Portable control unit
-  Mobile Steuereinheit
-  Unité de commande mobile
-  Unidad de control portátil

 Dati tecnici	 Technical data	 Technische Eigenschaften	 Caractéristiques techniques	 Datos técnico	
Diametro cerchio	Rim diameter	Felgendurchmesser	Diamètre de la jante	Diámetro llanta	13" - 27"
Diametro massimo ruota	Max.wheel diameter	Max.Reifendurchmesser	Diamètre max. du pneu	Diámetro máximo rueda	1.600 mm (63")
Larghezza massima ruota	Max.wheel width	Max.Reifenbreite	Largeur max. du pneu	Anchura máxima rueda	780 mm (31")
Peso massimo ruota	Max. wheel weight	Max. Radgewicht	Poids max. de la rue	Peso máximo rueda	1.270 Kg
Motore centralina idraulica	Motor of hydraulic pump	Motor der Hydraulikpumpe	Moteur de la pompe hydraulique	Motor centralita hidráulica	1,1 kW
Motore riduttore	Gear motor	Motorleistungdes Getriebes	Moteur du réducteur	Motor reductor	1,3/1,8 kW
Tensione di alimentazione trifase	Feeding tension (3-phase)	Drehstrom-Versorgungsspannung	Tension de alimentation triphasée	Tensión de alimentación trifásica	400V 50 Hz - 3 ph
Forza di stallonatura	Bead breaking force	Abdrückkraft	Force du détalonneur	Fuerza de destalonado	14700 N (1.500 Kg)
Pressione di esercizio	Operating pressure	Betriebsdruck	Pression de travail	Presión de servicio	0-130 bar





* Optional 230 V 50 Hz - 3 ph

The company reserves the right to introduce improvements in design or specification without prior notice







TITANIUM 2000

CE





-  Smontagomme elettroidraulico per rapido smontaggio e montaggio pneumatici con e senza camera d'aria di autocarri, autobus e veicoli industriali, con cerchi a canale e ad anello elastico.
-  **Easy demounting and mounting electro-hydraulic tyre changer for trucks, buses and industrial vehicles tubed or tubeless, with groove rim and split ring rim.**
-  Elektrohydraulische Reifenmontiermaschine für schlauchlose und Schlauchreifen für Lkw, Busse und Nutzfahrzeuge, mit Tiefbett- oder Sprengringfelgen.
-  Démonte-pneus électro-hydraulique pour camion pour le montage et le démontage de roues de camions, bus et véhicules industriels avec ou sans chambre à air, avec jante à rainure ou à bague fendue.
-  Desmontadora electrohidráulica para desmontaje y montaje rapido de neumáticos de camiones, autobuses y vehiculos industriales, con y sin cámara de aire, para llantas canal o llantas con anillo elástico.



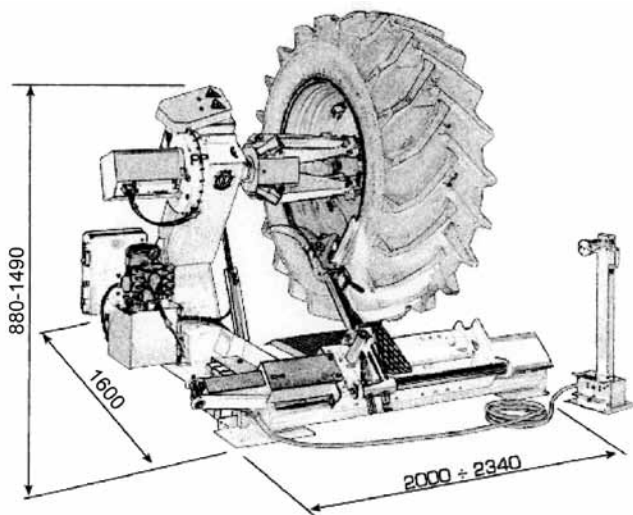



-  • Mandrino autocentrante a due velocità di rotazione (5 - 10 giri/minuto) • Per pneumatici tube e tubeless da 14" a 46" (56" con estensioni opzionali).
-  • Double speed self-centring chuck (5 - 10 rpm) • For tubeless and tube-type tyres from 14" to 46" diameters (56" with optional extensions).
-  • Selbstzentrierendes Universal-Spannfutter mit zwei Drehgeschwindigkeiten (5 - 10 UpM) • Für Reifen mit oder ohne Schlauch von 14" bis 46" Durchmesser (56" mit Sonderaufsätzen).
-  • Mandrin universel à deux vitesses (5 - 10 tours/min.) • Pour pneus avec chambre air et tubeless de 14" à 46" de diamètre (56" avec jeu de rallonges en option).
-  • Autocentrante con dos velocidades (5 - 10 rpm) • Para neumáticos tube y tubeless entre 14" y 46" (56" con extensiones opcionales).





TITANIUM 2000



-  Carrello con movimento idraulico e braccio utensili con traslazione manuale
-  Hydraulically operated carriage, tool holder arm with manual traverse
-  Schlitten mit hydraulischem Antrieb und Montagewerkzeug mit manueller Verfahrsteuerung
-  Chariot à mouvement hydraulique et bras porte-outils à translation manuelle
-  Carro con movimiento hidráulico y brazo para herramientas con traducción manual



-  Unità di controllo portatile
-  Portable control unit
-  Mobile Steuereinheit
-  Unité de commande mobile
-  Unidad de control portátil

 Dati tecnici	 Technical data	 Technische Eigenschaften	 Caractéristiques techniques	 Datos técnico	
Diametro cerchio	Rim diameter	Diamètre de la jante	Felgendurchmesser	Diámetro llanta	14" - 46" - 56"*
Diametro massimo ruota	Max.wheel diameter	Diamètre max. du pneu	Max.Reifendurchmesser	Diámetro máx. rueda	2.300 mm (90")
Larghezza massima ruota	Max.wheel width	Largeur max. du pneu	Max.Reifenbreite	Anchura máx. rueda	1.065 mm (41")
Peso massimo ruota	Max. wheel weight	Poids max. de la rue	Max. Radgewicht	Peso máx. rueda	1.500 Kg
Motore centralina idraulica	Motor of hydraulic pump	Moteur de la pompe hydraulique	Motor der Hydraulikpumpe	Motor centralita hidráulica	1,1 kW
Motore riduttore	Gear motor	Moteur du réducteur	Motorleistung des Getriebes	Motor reductor	1,3/1,8 kW
Tensione di alimentazione trifase	Feeding tension (3-phase)	Tension de alimentation triphasée	Drehstrom-Versorgungsspannung	Tensión de alimentación (trifásica)	400V 50 Hz - 3 ph
Forza di stallonatura	Bead breaking force	Force du détalonneur	Abdruckkraft	Fuerza de destalonado	15600 N (1.630 Kg)
Pressione di esercizio	Operating pressure	Pression de travail	Betriebsdruck	Presión de servicio	0-130 bar





* Optional

The company reserves the right to introduce improvements in design or specification without prior notice







TITANIUM 3000

CE

-  Smontagomme elettroidraulico per rapido smontaggio e montaggio pneumatici con e senza camera d'aria di autocarri, autobus e veicoli industriali, con cerchi a canale e ad anello elastico.
-  **Easy demounting and mounting electro-hydraulic tyre changer for trucks, buses and industrial vehicles tubed or tubeless, with groove rim and split ring rim.**
-  Elektrohydraulische Reifenmontiermaschine für schlauchlose und Schlauchreifen für Lkw, Busse und Nutzfahrzeuge, mit Tiefbett- oder Sprengringfelgen.
-  Démonte-pneus électro-hydraulique pour camion pour le montage et le démontage de roues de camions, bus et véhicules industriels avec ou sans chambre à air, avec jante à rainure ou à bague fendue.
-  Desmontadora electrohidráulica para desmontaje y montaje rapido de neumáticos de camiones, autobuses y vehiculos industriales, con y sin cámara de aire, para llantas canal o llantas con anillo elástico.



-  • Mandrino autocentrante a due velocità di rotazione (5 - 10 giri/minuto) • Per pneumatici tube e tubeless da 14" a 46" (56" con estensioni opzionali).
-  • Double speed self-centring chuck (5 - 10 rpm) • For tubeless and tube-type tyres from 14" to 46" diameters (56" with optional extensions).
-  • Selbstzentrierendes Universal-Spannfutter mit zwei Drehgeschwindigkeiten (5 - 10 UpM) • Für Reifen mit oder ohne Schlauch von 14" bis 46" Durchmesser (56" mit Sonderaufsätzen).
-  • Mandrin universel à deux vitesses (5 - 10 tours/min.) • Pour pneus avec chambre air et tubeless de 14" à 46" de diamètre (56" avec jeu de rallonges en option).
-  • Autocentrante con dos velocidades (5 - 10 rpm) • Para neumáticos tube y tubeless entre 14" y 46" (56" con extensiones opcionales).



- Mandrino autocentrante universale con capacità di bloccaggio da 14 a 46" (56" con prolunghe)
Rotazione oraria e antioraria del mandrino a due velocità
- Universal self-centring chuck with 14 to 46" clamping capacity (56" with extensions)
Clockwise and anticlockwise two speed chuck rotation
- Selbstzentrierendes Universal-Spannfutter für Felgen von 14" bis 46" (56" mit Spannbereichsverlängerungen)
Drehung des Spannfutters in Rechts- und Linkslauf mit zwei Geschwindigkeitsstufen
- Mandrin universel à centrage automatique avec capacité de blocage de 14 à 46" (56" avec rallonges)
Rotation du mandrin à deux vitesses en sens horaire ou antihoraire
- Mandril universal autocentrante con capacidad de bloqueo desde 14" hasta 46" (56" con extensiones).
Rotación horaria y antihoraria del mandril a dos velocidades.



- Ribaltamento automatico del braccio utensili
Doppia rotazione automatica dell'utensile
Posizionamento automatico del braccio
- Automatic tilt back of the tool arm
Automatic double tool rotation
Automatic arm positioning
- Werkzeugarm automatisch nach hinten kippbar
Automatische Werkzeugdrehung mit zwei Geschwindigkeitsstufen
Automatische Armpositionierung
- Basculement automatique du bras porte-outils
Rotation double automatique de l'outil
Positionnement automatique du bras
- Inclinación automática del brazo herramientas.
Doble rotación automática de la herramienta.
Posicionamiento automático del brazo.



- Unità di controllo portatile
- Portable control unit
- Mobile Steuereinheit
- Unité de commande mobile
- Unidad de control portátil

Dati tecnici	Technical data	Technische Eigenschaften	Caractéristiques techniques	Datos técnico	
Diametro cerchio	Rim diameter	Diamètre de la jante	Felgendurchmesser	Diámetro llanta	14" - 46" - 56"*
Diametro massimo ruota	Max.wheel diameter	Diamètre max. du pneu	Max.Reifendurchmesser	Diámetro máx. rueda	2.400 mm (94")
Larghezza massima ruota	Max.wheel width	Largeur max. du pneu	Max.Reifenbreite	Anchura máx. rueda	1.300 mm (51")
Peso massimo ruota	Max. wheel weight	Poids max. de la rue	Max. Radgewicht	Peso máx. rueda	1.580 Kg
Motore centralina idraulica	Motor of hydraulic pump	Moteur de la pompe hydraulique	Motor der Hydraulikpumpe	Motor centralita hidráulica	2,2 kW
Motore riduttore	Gear motor	Moteur du réducteur	Motorleistungdes Getriebes	Motor reductor	2,6/3,2 kW
Tensione di alimentazione trifase	Feeding tension (3-phase)	Tension de alimentation triphasée	Drehstrom-Versorgungsspannung	Tensión de alimentación (trifásica)	400V 50 Hz - 3 ph
Forza di stallonatura	Bead breaking force	Force du détalonneur	Abdrückkraft	Fuerza de destalonado	26380 N (2.690 Kg)
Pressione di esercizio	Operating pressure	Pression de travail	Betriebsdruck	Presión de servicio	0-130 bar ± 10% bar

* Optional

The company reserves the right to introduce improvements in design or specification without prior notice





OLIMP2500

CE









 Equilibratrice elettronica per equilibratura di ruote vetture, moto e veicoli commerciali leggeri.

 **Computerized wheel balancer for cars, motorcycles and light commercial vehicles.**

 Rechnerunterstützte Reifenauswuchtmaschine für PKW's, Motosräder und leichte Nutzfahrzeuge.

 Equilibreuse à microprocesseur pour roues voitures, motos et véhicules commerciaux légers.

 Equilibradora electrónica para equilibrado de ruedas de turismos, motos y vehículos comerciales ligeros.

-  • Autodiagnosi e autotaratura • Programma statico ruote moto • Pannello con pratiche vaschette portapesi • 3 funzioni ALU • Funzione ALU S
-  • Self-diagnosis and self calibration • Static motorbike-wheel program • User-friendly cover panel with weight holder • 3 ALU functions • ALU S function
-  • Kalibrierungs- und Diagnoseprogramme • Statikprogramm für Motorräder • Abdeckung mit praktischen Gewichtsaufnahmwannen • 3 ALU-Funktionen • ALU S Funktionen
-  • Auto étalonnage et auto diagnostique • Programme statique roues moto • Bac à plombs pratique • 3 fonctions ALU • Fonction ALU S
-  • Autodiagnóstico y autocalibrado • Programa estático de ruedas de moto • Panel con prácticas cubetas para las contrapesas • 3 funciones ALU • Funciones ALU S

Dati tecnici	Technical data	Technische Eigenschaften	Caractéristiques techniques	Datos técnico	
Alimentazione standard monofase	Standard power supply single phase	Stromversorgung, einphasig	Alimentation standard mono	Alimentación estándar monofásica	230V 50 Hz
Potenza max assorbita	Power draw	Leistungsaufnahme	Absorption	Potencia máx. absorbida	0,25 kW
Larghezza cerchione	Rim width	Felgenbreite	Largeur jante	Anchura llanta	1,5" - 20" (40 - 510 mm)
Diametro cerchione	Rim diameter	Felgendurchmesser	Diamètre jante	Diámetro llanta	10" - 24"
Peso massimo ruota	Max. wheel weight	Max. Radgewicht	Poids maxi de la roue	Peso máximo rueda	65 Kg
Tempo di ciclo	Spin time	Dauer Messlauf	Temps de cycle	Tiempo de ciclo	6 - 8 sec.
Velocità di equilibratura	Balancing speed	Auswuchtgeschwindigkeit	Vitesse de rotation	Velocidad de equilibrado	200 rpm
Precisione di equilibratura	Balancing accuracy	Auswuchtgenauigkeit	Précision d'équilibrage	Precisión de equilibrado	± 1 g
Dimensioni	Dimensions	Abmessungen	Encombrement	Medidas	1115x950x1700 mm
Dimensioni imballo	Packaging dimensions	Abmessungen, verpackt	Dimensions emballage		960x760x1160 mm
Peso netto con accessori standard	Net weight with standard accessories	Nettogewicht mit Standardzubehör	Poids net avec accessoires standard	Peso neto con accesorios estándar	96 Kg
Peso lordo	Gross weight	Bruttogewicht	Poids brut	Peso bruto	122 Kg

Accessori standard Standard accessories Standard-Zubehör Accessoires standards Accesorios estándar



Serie coni con ghiera rapida
 Set of cones with quick locking handle
 Konenset mit Schnellspannflansch
 Set de cônes avec bride rapide
 Juego de conos con brida rápida

Opzioni Optionals Sonderzubehör Options Opciones

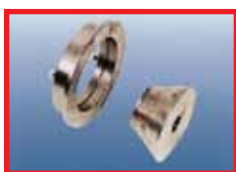

Flangia e cono per furgoni
 Flange and cone for light commercial vehicles
 Flansch und Kegel für Lieferwagen
 Bride et cône pour fourgons
 Brida y cono para furgonetas



Flangia ruote moto
 Adapter for motorcycle wheels
 Motorradflansch
 Plateau roues moto
 Brida ruedas de moto



Flangia universale
 Universal adapter
 Universaladapter
 Plateau universel
 Brida universal

The company reserves the right to introduce improvements in design or specification without prior notice





OLIMP6000

CE





 Equilibratrice elettronica per equilibratura di ruote vetture, moto e veicoli commerciali leggeri.

 **Computerized wheel balancer for cars, motorcycles and light commercial vehicles.**

 Rechnerunterstützte Reifenauswuchtmaschine für PKW's, Motosräder und leichte Nutzfahrzeuge.

 Equilibreuse à microprocesseur pour roues voitures, motos et véhicules commerciaux légers.

 Equilibradora electrónica para equilibrado de ruedas de turismos, motos y vehículos comerciales ligeros.

 • Autodiagnosi e autotaratura • Programma statico ruote moto • Pannello con pratiche vaschette portapesi • Rilevamento automatico diametro e distanza della ruota • Funzioni 'Alu' e 'Alu S' • Funzione Alu Split (divisione dei pesi e posizionamento dietro le razze) • Pedale freno

 • Self-diagnosis and self calibration • Static motorbike-wheel program • User-friendly cover panel with weight holder • Automatic measurement of wheel diameter and distance • ALU and ALU S functions • ALU SPLIT function • Brake pedal

 • Kalibrierungs- und Diagnoseprogramme • Statikprogramm für Motorräder • Abdeckung mit praktischen Gewichtsaufnahmekästen • Autom. Aufnahme von Abstand und Raddurchmesser • ALU und ALU S-Funktionen • ALU SPLIT-Funktion (Aufteilung der Gewichte und Positionierung hinter den Speichen) • Bremspedal

 • Auto étalonnage et auto diagnostique • Programme statique roues moto • Bac à plombs pratique • Mesure automatique du diamètre et de la distance de la roue • Fonctions Alu et Alu S • Fonction ALU SPLIT(masses cachées derrière les bâtons) • Pedal de freinage

 • Autodiagnóstico y autocalibrado • Programa estático de ruedas de moto • Panel con prácticas cubetas para las contrapesas • Medición automática de diámetro y distancia de la rueda • Funciones 'Alu' y 'Alu S' • Función Alu Split (división de pesos y colocación detrás de los radios) • Pedal de freno

Dati tecnici	Technical data	Technische Eigenschaften	Caractéristiques techniques	Datos técnico	
Alimentazione standard monofase	Standard power supply single phase	Stromversorgung, einphasig	Alimentation standard mono	Alimentación estándar monofásica	230V 50 Hz
Potenza max assorbita	Power draw	Leistungsaufnahme	Absorption	Potencia máx. absorbida	0,25 kW
Larghezza cerchione	Rim width	Felgenbreite	Largeur jante	Anchura llanta	1,5" - 20" (40 - 510 mm)
Diametro cerchione	Rim diameter	Felgendurchmesser	Diamètre jante	Diámetro llanta	10" - 24"
Peso massimo ruota	Max. wheel weight	Max. Radgewicht	Poids maxi de la roue	Peso máximo rueda	65 Kg
Tempo di ciclo	Spin time	Dauer Messlauf	Temps de cycle	Tiempo de ciclo	6 - 8 sec.
Velocità di equilibratura	Balancing speed	Auswuchtgeschwindigkeit	Vitesse de rotation	Velocidad de equilibrado	200 rpm
Precisione di equilibratura	Balancing accuracy	Auswuchtgenauigkeit	Précision d'équilibrage	Precisión de equilibrado	± 1 g
Dimensioni	Dimensions	Abmessungen	Encombrement	Medidas	1115x950x1700 mm
Dimensioni imballo	Packaging dimensions	Abmessungen, verpackt	Dimensions emballage		960x760x1160 mm
Peso netto con accessori standard	Net weight with standard accessories	Nettogewicht mit Standardzubehör	Poids net avec accessoires standard	Peso neto con accesorios estándar	102 Kg
Peso lordo	Gross weight	Bruttogewicht	Poids brut	Peso bruto	130 Kg

Accessori standard Standard accessories Standard-Zubehör Accessoires standards Accesorios estándar



Serie coni con ghiera rapida
 Set of cones with quick locking handle
 Konenset mit Schnellspannflansch
 Set de cônes avec bride rapide
 Juego de conos con brida rápida

Opzioni Optionals Sonderzubehör Options Opciones

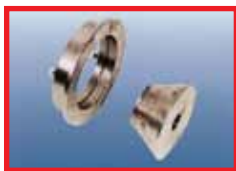

Flangia e cono per furgoni
 Flange and cone for light commercial vehicles
 Flansch und Kegel für Lieferwagen
 Bride et cône pour fourgons
 Brida y cono para furgonetas



Flangia ruote moto
 Adapter for motorcycle wheels
 Motorradflansch
 Plateau roues moto
 Brida ruedas de moto



Flangia universale
 Universal adapter
 Universaladapter
 Plateau universel
 Brida universal

The company reserves the right to introduce improvements in design or specification without prior notice





OLIMP6000 C

CE





 Equilibratrice elettronica per equilibratura di ruote vetture, moto e veicoli commerciali leggeri.

 **Computerized wheel balancer for cars, motorcycles and light commercial vehicles.**

 Rechnerunterstützte Reifenauswuchtmaschine für PKW's, Motosräder und leichte Nutzfahrzeuge.

 Equilibreuse à microprocesseur pour roues voitures, motos et véhicules commerciaux légers.

 Equilibradora electrónica para equilibrado de ruedas de turismos, motos y vehículos comerciales ligeros.

 • Autodiagnosi e autotaratura • Programma statico ruote moto • Pannello con pratiche vaschette portapesi • Rilevamento automatico diametro, distanza e larghezza • Funzioni 'Alu' e 'Alu S' • Funzione Alu Split (divisione dei pesi e posizionamento dietro le razze) • Ottimizzazione squilibrio • Programma statico • Funzione doppio operatore • Pedale freno posizione ruota in posizione di correzione dello squilibrio

 • Self-diagnosis and self calibration • Static motorbike-wheel program • User-friendly cover panel with weight trays • Automatic measurement of wheel diameter, distance and width • ALU and ALU S functions • ALU SPLIT function • Unbalance optimization • Static program • Double operator function • Brake pedal for wheel positioning in balancing position

 • Kalibrierungs- und Diagnoseprogramme • Statikprogramm für Motorradräder • Abdeckung mit praktischen Gewichtsaufnahmewannen • Autom. Aufnahme von Abstand, Raddurchmesser und Radbreite • ALU und ALU S-Funktionen • ALU SPLIT-Funktion (Aufteilung der Gewichte und Positionierung hinter den Speichen) • Unwucht-Optimierungsprogramm • Statik-Programm • Doppelbedienerfunktion • Bremspedal für genaue Radpositionierung in Unwucht-Korrekturstellung

 • Auto étalonnage et auto diagnostique • Programme statique roues moto • Bac à plombs pratique • Mesure automatique du diamètre, de la distance et de la largeur de la roué • Fonctions Alu et Alu S • Fonction ALU SPLIT(masses cachées derrière les bâtons) • Programme d'optimisation • Programme statique • Fonction double opérateur • Pedal de freinage pour positionnement de la roue en position de correction

 • Autodiagnóstico y autocalibrado • Programa estático de ruedas de moto • Panel con prácticas cubetas para las contrapesas • Medición automática de diámetro, distancia y anchura de la rueda • Funciones 'Alu' y 'Alu S' • Función Alu Split (división de pesos y colocación detrás de los radios) • Optimización del desequilibrio • Programa estático • Función doble operario • Pedal de freno de la rueda en posición de corrección del desequilibrio

Dati tecnici	Technical data	Technische Eigenschaften	Caractéristiques techniques	Datos técnico	
Alimentazione standard monofase	Standard power supply single phase	Stromversorgung, einphasig	Alimentation standard mono	Alimentación estándar monofásica	230V 50 Hz
Potenza max assorbita	Power draw	Leistungsaufnahme	Absorption	Potencia máx. absorbida	0,25 kW
Larghezza cerchione	Rim width	Felgenbreite	Largeur jante	Anchura llanta	1,5" - 20" (40 - 510 mm)
Diametro cerchione	Rim diameter	Felgendurchmesser	Diamètre jante	Diámetro llanta	10" - 24"
Peso massimo ruota	Max. wheel weight	Max. Radgewicht	Poids maxi de la roue	Peso máximo rueda	65 Kg
Tempo di ciclo	Spin time	Dauer Messlauf	Temps de cycle	Tiempo de ciclo	6 - 8 sec.
Velocità di equilibratura	Balancing speed	Auswuchtgeschwindigkeit	Vitesse de rotation	Velocidad de equilibrado	200 rpm
Precisione di equilibratura	Balancing accuracy	Auswuchtgenauigkeit	Précision d'équilibrage	Precisión de equilibrado	± 1 g
Dimensioni	Dimensions	Abmessungen	Encombrement	Medidas	1115x950x1700 mm
Dimensioni imballo	Packaging dimensions	Abmessungen, verpackt	Dimensions emballage		960x760x1160 mm
Peso netto con accessori standard	Net weight with standard accessories	Nettogewicht mit Standardzubehör	Poids net avec accessoires standard	Peso neto con accesorios estándar	102 Kg
Peso lordo	Gross weight	Bruttogewicht	Poids brut	Peso bruto	130 Kg

Accessori standard Standard accessories Standard-Zubehör Accessoires standards Accesorios estándar



Serie coni con ghiera rapida
 Set of cones with quick locking handle
 Konenset mit Schnellspannflansch
 Set de cônes avec bride rapide
 Juego de conos con brida rápida

Opzioni Optionals Sonderzubehör Options Opciones



Flangia e cono per furgoni
 Flange and cone for light commercial vehicles
 Flansch und Kegel für Lieferwagen
 Bride et cône pour fourgons
 Brida y cono para furgonetas



Flangia ruote moto
 Adapter for motorcycle wheels
 Motorradflansch
 Plateau roues moto
 Brida ruedas de moto



Flangia universale
 Universal adapter
 Universaladapter
 Plateau universel
 Brida universal

The company reserves the right to introduce improvements in design or specification without prior notice





OLIMP9500

CE





 Equilibratrice elettronica, con schermo a colori, per equilibratura di ruote, moto e veicoli commerciali leggeri.

 **Computerized wheel balancer with colour monitor for cars, motorcycles and light commercial vehicles.**

 Rechnerunterstützte Reifenauswuchtmaschine mit Farbmonitor für PKW's, Motosräder und leichte Nutzfahrzeuge.

 Equilibreuse à microprocesseur avec écran couleur pour roues voitures, motos et véhicules commerciaux légers.

 Equilibradora electrónica con pantalla en color de para equilibrado de ruedas de turismos, motos y vehículos comerciales ligeros.

 • Autodiagnosi e autotaratura • Programma statico ruote moto • Pannello con pratiche vaschette portapesi • Rilevamento automatico diametro, distanza e larghezza • Funzioni 'Alu' e 'Alu S' • Funzione Alu Split (divisione dei pesi e posizionamento dietro le razze) • Ottimizzazione squilibrio • Programma statico • Funzione doppio operatore • Pedale freno posizione ruota in posizione di correzione dello squilibrio

 • Self-diagnosis and self calibration • Static motorbike-wheel program • User-friendly cover panel with weight trays • Automatic measurement of wheel diameter, distance and width • ALU and ALU S functions • ALU SPLIT function • Unbalance optimization • Static program • Double operator function • Brake pedal for wheel positioning in balancing position

 • Kalibrierungs- und Diagnoseprogramme • Statikprogramm für Motorradräder • Abdeckung mit praktischen Gewichtsaufnahmewannen • Autom. Aufnahme von Abstand, Raddurchmesser und Radbreite • ALU und ALU S-Funktionen • ALU SPLIT-Funktion (Aufteilung der Gewichte und Positionierung hinter den Speichen) • Unwucht-Optimierungsprogramm • Statik-Programm • Doppelbedienerfunktion • Bremspedal für genaue Radpositionierung in Unwucht-Korrekturstellung

 • Auto étalonnage et auto diagnostique • Programme statique roues moto • Bac à plombs pratique • Mesure automatique du diamètre, de la distance et de la largeur de la roué • Fonctions Alu et Alu S • Fonction ALU SPLIT(masses cachées derrière les bâtons) • Programme d'optimisation • Programme statique • Fonction double opérateur • Pedal de freinage pour positionnement de la roue en position de correction

 • Autodiagnóstico y autocalibrado • Programa estático de ruedas de moto • Panel con prácticas cubetas para las contrapesas • Medición automática de diámetro, distancia y anchura de la rueda • Funciones 'Alu' y 'Alu S' • Función Alu Split (división de pesos y colocación detrás de los radios) • Optimización del desequilibrio • Programa estático • Función doble operario • Pedal de freno de la rueda en posición de corrección del desequilibrio

Dati tecnici	Technical data	Technische Eigenschaften	Caractéristiques techniques	Datos técnico	
Alimentazione standard monofase	Standard power supply single phase	Stromversorgung, einphasig	Alimentation standard mono	Alimentación estándar monofásica	230V 50 Hz
Potenza massima assorbita	Power draw	Leistungsaufnahme	Absorption	Potencia máxima absorbida	300 W
Larghezza cerchione	Rim width	Felgenbreite	Largeur jante	Anchura llanta	1,5" - 20" (40 - 510 mm)
Diametro impostabile	Rim diameter	Felgendurchmesser	Diamètre jante	Diámetro configurable	10" - 24"
Peso massimo ruota	Max. wheel weight	Max. Radgewicht	Poids maxi de la roue	Peso máximo rueda	65 Kg
Tempo di ciclo	Spin time	Dauer Messlauf	Temps de cycle	Tiempo de ciclo	6 - 8 sec.
Velocità di equilibratura	Balancing speed	Auswuchtgeschwindigkeit	Vitesse de rotation	Velocidad de equilibrado	200 rpm
Precisione di equilibratura	Balancing accuracy	Auswuchtgenauigkeit	Précision d'équilibrage	Precisión de equilibrado	± 1 gr
Dimensioni	Dimensions	Abmessungen	Encombrement	Medidas	1115x950x1700 mm
Dimensioni imballo	Packaging dimensions	Abmessungen, verpackt	Dimensions emballage	Medidas embalaje	960x760x1060 mm
Peso netto con accessori standard	Net weight with standard accessories	Nettogewicht mit Standardzubehör	Poids net avec accessoires standard	Peso neto con accesorios estándar	103 Kg
Peso lordo	Gross weight	Bruttogewicht	Poids brut	Peso bruto	131 Kg

Accessori standard Standard accessories Standard-Zubehör Accessoires standards Accesorios estándar



Serie coni con ghiera rapida
 Set of cones with quick locking handle
 Konenset mit Schnellspannflansch
 Set de cônes avec bride rapide
 Juego de conos con brida rápida

Opzioni Optionals Sonderzubehör Options Opciones



Flangia e cono per furgoni
 Flange and cone for light commercial vehicles
 Flansch und Kegel für Lieferwagen
 Bride et cône pour fourgons
 Brida y cono para furgonetas



Flangia ruote moto
 Adapter for motorcycle wheels
 Motorradflansch
 Plateau roues moto
 Brida ruedas de moto



Flangia universale
 Universal adapter
 Universaladapter
 Plateau universel
 Brida universal

The company reserves the right to introduce improvements in design or specification without prior notice





CE





 Equilibratrice elettronica per equilibratura statica e dinamica di ruote vetture, moto e veicoli commerciali leggeri.

 **Computerized wheel balancer for cars, motorcycles and light commercial vehicles.**

 Rechnerunterstützte Reifenauswuchtmaschine für PKW's, Motosräder und leichte Nutzfahrzeuge.

 Equilibreuse à microprocesseur pour roues voitures, motos et véhicules commerciaux légers.

 Equilibradora electrónica para equilibrado estático y dinámico de ruedas de turismos, motos y vehículos comerciales ligeros.

 • Autodiagnosi e autotatura • Programma statico ruote moto • Pannello con pratiche vaschette portapesi • 4 funzioni ALU + ALU S + SPLIT per cerchi a razze • Ottimizzazione squilibrio (compensazione squilibrio pneumatico e squilibrio cerchione)

 • Self-diagnosis and self calibration • Static motorbike-wheel program • User-friendly cover panel with weight holder • 4 ALU functions + ALU S + SPLIT • Unbalance optimization (compensation of rim and tyre unbalance)

 • Kalibrierungs- und Diagnoseprogramme • Statikprogramm für Motorräder • Abdeckung mit praktischen Gewichtsaufnahmewannen • 4 ALU-Funktionen + ALU S + SPLIT f. Speichenfelgen • Unwucht-Optimierungsprogramm (Ausgleich zw. Reifenunwucht und Felgenunwucht)

 • Auto étalonnage et auto diagnostique • Programme statique roues moto • Bac à plombs pratique • 4 fonctions ALU + ALU S + SPLIT pour jantes à rayon • Programme d'optimisation (compensation du balourd pneumatique et balourd jante)

 • Autodiagnóstico y autocalibrado • Programa estático de ruedas de moto • Panel con prácticas cubetas para las contrapesas • 4 funciones ALU + ALU S + SPLIT para llantas de radios • Optimización desequilibrio (compensación del desequilibrio del neumático y del desequilibrio de la llanta)

Dati tecnici	Technical data	Technische Eigenschaften	Caractéristiques techniques	Datos técnico	
Alimentazione standard monofase	Standard power supply single phase	Stromversorgung, einphasig	Alimentation standard mono	Alimentación estándar monofásica	115/230V 50/60 Hz
Potenza max assorbita	Power draw	Leistungsaufnahme	Absorption	Potencia máx. absorbida	0,8 kW
Larghezza cerchione	Rim width	Felgenbreite	Largeur jante	Anchura llanta	1,5 - 20" (40 - 510 mm)
Diametro cerchione	Rim diameter	Felgendurchmesser	Diamètre jante	Diámetro llanta	10' - 26" (265 - 665 mm)
Distanza cerchio-macchina	Distance rim to balancer	Abstand Felge-Maschine	Distance jante-équilibreuse	Distancia llanta-máquina	0 - 265 mm
Peso massimo ruota	Max. wheel weight	Max. Radgewicht	Poids maxi de la roue	Peso máximo rueda	75 Kg
Tempo di ciclo	Spin time	Dauer Messlauf	Temps de cycle	Tiempo de ciclo	6 - 8 sec.
Velocità di equilibratura (min/max)	Balancing speed (min/max)	Auswuchtgeschwindigkeit (min/max)	Vitesse de rotation (min/max)	Velocidad de equilibrado (min./máx.)	<100 min
Precisione di equilibratura	Balancing accuracy	Auswuchtgenauigkeit	Précision d'équilibrage	Precisión de equilibrado	1 gr
Dimensioni	Dimensions	Abmessungen	Encombrement	Medidas	1234 x 1015 x (h) 1238 mm
Dimensioni imballo	Packaging dimensions	Abmessungen, verpackt	Dimensions emballage	Medidas embalaje	1000 x 850 x (h) 1450 mm
Peso netto con accessori standard	Net weight with standard accessories	Nettogewicht mit Standardzubehör	Poids net avec accessoires standard	Peso neto con accesorios estándar	100 Kg
Peso lordo	Gross weight	Bruttogewicht	Poids brut	Peso bruto	120 Kg



Serie coni con ghiera rapida
Set of cones with quick locking handle
Konenset mit Schnellspannflansch
Set de cônes avec bride rapide
Juego de conos con brida rápida

Protezione ruota
Wheel hood
Radschutzhaube
Carter de sécurité
Protección rueda

Opzioni Optionals Sonderzubehör Options Opciones



V923-V0197

Flangia e cono per ruote con foro da 97 a 170 mm
Flange and cone for rims with central hole from 97 to 170 mm
Flansch und Kegel für Reifen mit Bohrung von 97 bis 170 mm
Bride et cône pour jantes avec trou central de 97 à 170 mm
Brida y cono para ruedas con agujero entre 97 y 170 mm



V1070

Flangia ruote moto
Adapter for motorcycle wheels
Motorradflansch
Plateau roues moto
Brida ruedas de moto



V996

Flangia universale
Universal adapter
Universaladapter
Plateau universel
Brida universal

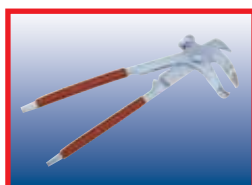

033

Pinza per piombi
Weight pliers
Gewichtsmontierzange
Pince pour masselottes
Alicates para contrapesas

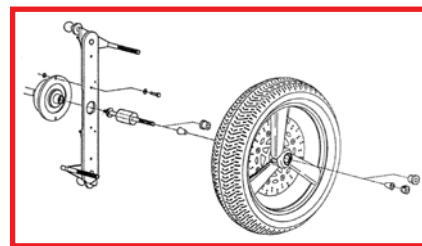

V255

Flangia ruote moto PRO
Adapter for motorcycle wheels PRO
Motorradflansch PRO
Plateau roues moto PRO
Brida ruedas de moto PRO

The company reserves the right to introduce improvements in design or specification without prior notice





VEGA PRO

CE





 Equilibratrice elettronica per equilibratura statica e dinamica di ruote vetture, moto e veicoli commerciali leggeri.

 **Computerized wheel balancer for cars, motorcycles and light commercial vehicles.**

 Rechnerunterstützte Reifenauswuchtmaschine für PKW's, Motosräder und leichte Nutzfahrzeuge.

 Equilibreuse à microprocesseur pour roues voitures, motos et véhicules commerciaux légers.

 Equilibradora electrónica para equilibrado estático y dinámico de ruedas de turismos, motos y vehículos comerciales ligeros.

 L'equilibratrice è adatta ad equilibrare ruote di vettura, veicoli commerciali leggeri e motocicli di peso inferiore ai 75 Kg. È dotata di Funzioni: ALU-S; SPLIT; Ottimizzazione squilibrio; Autodiagnosi; Autotaratura; Funzione doppio operatore.

 The machine is designed for balancing wheels of car, light commercial vehicles or motorcycle, weighing less than 75 Kg. The following functions are provided: Double operator; ALU-S; SPLIT; Unbalance optimization; Self diagnostics; Self-calibration; Double operator function.

 Mit dieser stationären Auswuchtmaschine können PKW-, Lkw- und Motorradräder bis zu einem Gewicht von 75 Kg dynamisch und/oder statisch ausgewuchtet werden. Sie ist mit den Funktionen ausgestattet: Zweibediener; ALU-S; SPLIT; Unwuchtoptimierung; Selbstdiagnose; Selbstkalibrierung; Doppelbedienerfunktion.

 Equilibreuse pour l'équilibrage de roues de voitures, de véhicules commerciaux légers ou de motos dont le poids est inférieur à 75kg. Fonctions: Deux opérateurs; ALU-S; SPLIT; Optimisation balourd; Autodiagnostic; Autoétalonnage; Fonction double opérateur.

 La equilibradora es idónea para equilibrar ruedas de turismos, vehículos comerciales ligeros y motocicletas de peso inferior a 75 Kg. Tiene funciones: ALUS; SPLIT; Optimización desequilibrio; Autodiagnóstico; Autocalibrado; Función doble operario.

Dati tecnici	Technical data	Technische Eigenschaften	Caractéristiques techniques	Datos técnico	
Alimentazione monofase	Single phase power supply	Einphasen-Stromversorgung	Alimentation monophasée	Alimentación monofásica	115/230V 50/60 Hz
Peso con protezione (esclusa flangia)	Weight with guard (excluding adapter)	Gewicht mit Schutzhaube (ohne Flansch)	Poids avec protection (sauf la bride)	Peso con protección (excluida la brida)	92 Kg
Larghezza cerchione impostabile	Rim width setting range	Felgenbreite	Largeur jante programmable	Anchura de llanta configurable	1,5 - 20" (40 - 510 mm)
Diametro impostabile	Diameter setting range	Felgendurchmesser	Diamètre programmable	Diámetro configurable	10' - 24" (265 - 615 mm)
Peso massimo ruota	Max. wheel weight	Max. Radgewicht	Poids maxi de la roue	Peso máximo rueda	75 Kg
Classe protezione	Protection class	Schutzart	Classe de protection	Clase de protección	IP 54
Potenza massima assorbita	Max power consumption	Maximale Leistungsaufnahme	Puissance maximum absorbée	Potencia máxima absorbida	800 W
Velocità di equilibratura	Balancing speed	Auswuchtdrehzahl	Vitesse d'équilibrage	Velocidad de equilibrado	< 100 min (-1)
Tempo di ciclo per ruota media (14 KG)	Cycle time for average wheel (14 KG)	Messzeit (Standardrad ca.14 Kg)	Temps de cycle pour roue moyenne (14 Kg)	Tiempo de ciclo para rueda media (14 KG)	6 - 8 s
Risoluzione massima della misura	Max resolution of measurement	Auswuchtgenauigkeit	Définition maximum de la mesure	Resolución máxima de la medición	1 g
Risoluzione della posizione	Position resolution	Positioniergenauigkeit	Définition de la position	Resolución de la posición	± 1,4°
Rumorosità media	Average noise	Mittlerer Schalldruckpegel	Nuisance sonore moyenne	Ruido medio	< 70dB (A)
Distanza cerchio-macchina	Rim-machine distance	Abstand Felge/Maschine	Distance jante - machine	Distancia llanta-máquina	0 - 265 mm
Diametro totale ruota entro protezione	Total wheel diameter inside guard	Gesamtdurchmesser Rad in Schutzgehäuse	Diamètre total roue à l'intérieur de la protection	Diámetro total rueda dentro de la protección	870 mm standard 67 mm (42")
Larghezza totale ruota entro protezione	Total wheel width inside guard	Gesamtbreite Rad in Schutzgehäuse	Largeur totale roue à l'intérieur de la protection	Anchura total rueda dentro de la protección	430 mm standard 500 mm (42")

	Calibro elettronico rilevamento distanza e diametro	Protezione ruota
	Electronic distance and diameter gauge	Wheel hood
	Elektronische Abstands und Durchmesser-Messtaster	Radschutzhaube
	Jauge électronique de distance et diamètre	Carter de sécurité
	Calibre electrónico medición distancia y diámetro	Protección rueda

Opzioni Optionals Sonderzubehör Options Opciones



V923-V0197

Flangia e cono per ruote con foro da 97 a 170 mm
 Flange and cone for rims with central hole from 97 to 170 mm
 Flansch und Kegel für Reifen mit Bohrung von 97 bis 170 mm
 Bride et cône pour jantes avec trou central de 97 à 170 mm
 Brida y cono para ruedas con agujero entre 97 y 170 mm



V1070

Flangia ruote moto
 Adapter for motorcycle wheels
 Motorradflansch
 Plateau roues moto
 Brida ruedas de moto



V996

Flangia universale
 Universal adapter
 Universaladapter
 Plateau universel
 Brida universal

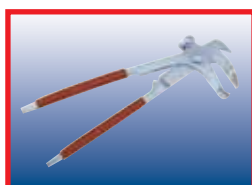

033

Pinza per piombi
 Weight pliers
 Gewichtsmontierzange
 Pince pour masselottes
 Alicates para contrapesas

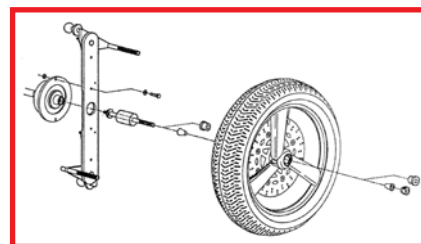

V255

Flangia ruote moto PRO
 Adapter for motorcycle wheels PRO
 Motorradflansch PRO
 Plateau roues moto PRO
 Brida ruedas de moto PRO

SONAR LA

Misuratore elettronico larghezza ruota
 Electronic wheel width sensor
 Elektronischer Sensor für Felgenbreite
 Capteur électronique largeur roue
 Medidor electrónico anchura rueda

The company reserves the right to introduce improvements in design or specification without prior notice





QUASAR

CE





 Equilibratrice elettronica per vetture, autobus e camion con sollevatore pneumatico ruota.

 **Computerized electronic wheel balancer with pneumatic wheel lift for cars, coaches and trucks.**

 Rechnerunterstützte Reifenauswuchtmaschine für LKW, PKW und Busse; mit pneumatischem Radheber.

 Equilibreuse à microprocesseur pour roues voitures, tourisme et poids lourds avec élévateur pneumatique roues.

 Equilibradora electrónica para turismos, autobuses y camiones con elevador neumático de la rueda.

 • Autotaratura con qualsiasi ruota • Pannello con pratiche vaschette portapesi • Funzioni 'Alu' e 'Alu S' • Leva freno • Sollevatore pneumatico ruota

 • Self calibration with any kind of wheel • User-friendly cover panel with weight trays • Brake lever • ALU and ALU S functions • Pneumatic wheel lift

 • Kalibrierungsprogramm • Abdeckung mit praktischen Gewicht-saufnahmewannen • Bremshebel • ALU und ALU S-Funktionen • Pneumatischer Radheber

 • Auto étalonnage • Bac à plombs pratique • Levier frein • Fonctions 'Alu' et 'Alu S' • Élévateur pneumatique roues

 • Autocalibrado con cualquier rueda • Panel con prácticas cubetas para las contrapesas • Funciones 'Alu' y 'Alu S' • Palanca de freno • Elevador neumático de rueda



Dati tecnici	Technical data	Technische Eigenschaften	Caractéristiques techniques	Datos técnico
Alimentazione standard monofase	Standard power supply single phase	Stromversorgung, einphasig	Alimentation standard mono	Alimentación estándar monofásica
Potenza massima assorbita	Power draw	Leistungsaufnahme	Absorption	Potencia máxima absorbida
Larghezza cerchione	Rim width	Felgenbreite	Largeur jante	Anchura llanta
Diametro cerchione	Rim diameter	Felgendurchmesser	Diamètre jante	Diámetro llanta
Peso massimo ruota	Max. wheel weight	Max. Radgewicht	Poids maxi de la roue	Peso máximo rueda
Tempo di ciclo	Spin time	Dauer Messlauf	Temps de cycle	Tiempo de ciclo
Velocità di equilibratura (min/max)	Balancing speed (min/max)	Auswuchtgeschwindigkeit (min/max)	Vitesse de rotation (min/max)	Velocidad de equilibrado (min./máx.)
Precisione di equilibratura	Balancing accuracy	Auswuchtgenauigkeit	Précision d'équilibrage	Precisión de equilibrado
Dimensioni	Dimensions	Abmessungen	Encombrement	Medidas
Dimensioni imballo	Packaging dimensions	Abmessungen, verpackt	Dimensions emballage	Medidas embalaje
Peso netto con accessori standard	Net weight with standard accessories	Nettogewicht mit Standardzubehör	Poids net avec accessoires standard	Peso neto con accesorios estándar
Peso lordo	Gross weight	Bruttogewicht	Poids brut	Peso bruto
Pressione aria compressa	Required air pressure	Luftdruck	Pression air nécessaire	Presión aire comprimido



Serie coni con ghiera manuale
Set of cones with standard locking handle
Konenset mit Standard-Spannflansch
Cônes avec écrou standard
Juego de conos con brida rápida



Opzioni



Optionals



Sonderzubehör



Options



Opciones



V996
Flangia universale
Universal adapter
Universaladapter
Plateau universel
Brida universal

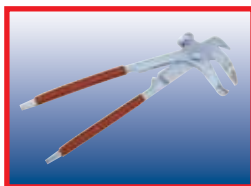

033
Pinza per piombi
Weight pliers
Gewichtsmontierzange
Pince pour masselottes
Alicates para contrapesas

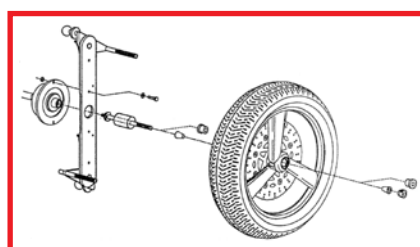

V255
Flangia ruote moto PRO
Adapter for motorcycle wheels PRO
Motorradflansch PRO
Plateau roues moto PRO
Brida ruedas de moto PRO

V1016
Serie coni addizionali per veicoli commerciali
Set of additional cones for trucks
Zusatz-Konenset für LKW
Jeu de cônes additionnels pour poids lourds
Juego de conos adicionales para vehículos comerciales





GALAXY 1255

CE





 Equilibratrice elettronica per equilibratura di ruote vetture, moto e veicoli commerciali leggeri.

 **Computerized wheel balancer for cars, motorcycles and light commercial vehicles.**

 Rechnerunterstützte Reifenauswuchtmaschine für PKW's, Motosräder und leichte Nutzfahrzeuge.

 Equilibreuse à microprocesseur pour roues voitures, motos et véhicules commerciaux légers.

 Equilibradora electrónica para equilibrado de ruedas de turismos, motos y vehículos comerciales ligeros.

 • Autodiagnosi e autotaratura • Pannello con pratiche vaschette portapesi • Rilevamento automatico diametro e distanza della ruota • 5 programmi ALU per l'equilibratura dinamica con pesi adesivi • 3 programmi di equilibratura statica (con pesi a molletta o adesivi) • 2 programmi speciali per pneumatici Pax con misure in mm • Ottimizzazione squilibrio • Pedale freno

 • Self-diagnosis and self calibration • User-friendly cover panel with weight holder • Automatic measurement of wheel diameter and distance • 5 programs ALU for dynamic balancing with adhesive weights • 3 programs for static balancing (with spring weights or adhesive weights) • 2 special programs for PAX tires with mm measures • Unbalance optimization • Pedal brake.

 • Kalibrierungs- und Diagnoseprogramme • Abdeckung mit praktischen Gewichtsaufnahme-wannen • Autom. Aufnahme von Abstand und Raddurchmesser • 5 ALU Programme zum dynamischen Auswuchten mit Klebstoffengewichten • 3 statische Auswuchtprogramme (mit Federgewichten oder Klebstoffengewichten) • 2 spezielle Programme für Pax-Reifen mit mm Größe • Unwucht-Optimierungsprogramm • Bremspedal.

 • Auto étalonnage et auto diagnostique • Bac à plombs pratique • Mesure automatique du diamètre et de la distance de la roue • 5 programmes ALU pour équilibrage dynamique avec des masses adhésifs • 3 programmes pour équilibrage statique (avec masses à ressort ou masses adhésifs) • 2 programmes spéciaux pour les pneus Pax avec dimensions en mm • Programme optimisation équilibrage • pédale de freinage.

 • Autodiagnóstico y autocalibrado • Panel con prácticas cubetas para las contrapesas • Medición automática de diámetro y distancia de la rueda • 5 programas ALU para el equilibrio dinámico con pesos adhesivos • 3 programas de equilibrio estático (con pesos con resorte o con pesos adhesivos) • 2 programas especiales para neumáticos Pax con medidas en mm • Programa optimización desequilibrio • Pedal del freno.



Dati tecnici	Technical data	Technische Eigenschaften	Caractéristiques techniques	Datos técnico
Alimentazione standard monofase	Standard power supply single phase	Stromversorgung, einphasig	Alimentation standard mono	Alimentación estándar monofásica
Potenza max assorbita	Power draw	Leistungsaufnahme	Absorption	Potencia máx. absorbida
Larghezza cerchione	Rim width	Felgenbreite	Largeur jante	Anchura llanta
Diametro cerchione	Rim diameter	Felgendurchmesser	Diamètre jante	Diámetro llanta
Peso massimo ruota	Max. wheel weight	Max. Radgewicht	Poids maxi de la roue	Peso máximo rueda
Tempo di ciclo	Spin time	Dauer Messlauf	Temps de cycle	Tiempo de ciclo
Velocità di equilibratura	Balancing speed	Auswuchtgeschwindigkeit	Vitesse de rotation	Velocidad de equilibrado
Precisione di equilibratura	Balancing accuracy	Auswuchtgenauigkeit	Précision d'équilibrage	Precisión de equilibrado
Dimensioni	Dimensions	Abmessungen	Encombrement	Medidas
Dimensioni imballo	Packaging dimensions	Abmessungen, verpackt	Dimensions emballage	
Peso netto con accessori standard	Net weight with standard accessories	Nettogewicht mit Standardzubehör	Poids net avec accessoires standard	Peso neto con accesorios estándar
Peso lordo	Gross weight	Bruttogewicht	Poids brut	Peso bruto

Accessori standard
 Standard accessories
 Standard-Zubehör
 Accessoires standards
 Accesorios estándar



Flangia completa a coni
 Flange complete with cones
 Complettler Kegelflansch
 Plateau complet de cône
 Brida y cono para furgonetas



Peso campione da 100 gr / Pinza
 100g. sample weight / Pliers
 Mustergewicht Gewicht von 100 gr. / Zange
 Masse étalon du poids de 100 g. / Pince
 Peso muestra de 100 gr. / Tenazas



Calibro
 Gauge
 Compás
 Calibre
 Lehre

Opzioni
 Optionals
 Sonderzubehör
 Options
 Opciones



Distanziale, 4° cono, 5° cono
 4rd - 5th cone spacer
 Abstandstück, 4° Kegel, 5° Kegel
 Entretoise 4^{ème} cône, 5^{ème} cône
 Distanciadador, 4° cono, 5° cono



Flangia moto
 Motorcycle flange
 Motorradflansch
 Plateau moto
 Adaptador de moto



Flangia 3 -4 -5 fori
 3 -4 -5 hole flange
 Flansch mit 3 -4 -5 Bohrungen
 Plateau à 3 -4 -5 trous
 Adaptador 3 -4 -5 agujeros





GALAXY 1277

CE





 Equilibratrice elettronica per equilibratura di ruote vetture, moto e veicoli commerciali leggeri.

 **Computerized wheel balancer for cars, motorcycles and light commercial vehicles.**

 Rechnerunterstützte Reifenauswuchtmaschine für PKW's, Motosräder und leichte Nutzfahrzeuge.

 Equilibreuse à microprocesseur pour roues voitures, motos et véhicules commerciaux légers.

 Equilibradora electrónica para equilibrado de ruedas de turismos, motos y vehículos comerciales ligeros.

 • Autodiagnosi e autotaratura • Pannello con pratiche vaschette portapesi • Rilevamento automatico diametro e distanza della ruota • 5 programmi ALU per l'equilibratura dinamica con pesi adesivi • 3 programmi di equilibratura statica (con pesi a molletta o adesivi) • 2 programmi speciali per pneumatici Pax con misure in mm • Ottimizzazione squilibrio • Pedale freno

 • Self-diagnosis and self calibration • User-friendly cover panel with weight holder • Automatic measurement of wheel diameter and distance • 5 programs ALU for dynamic balancing with adhesive weights • 3 programs for static balancing (with spring weights or adhesive weights) • 2 special programs for PAX tires with mm measures • Unbalance optimization • Pedal brake.

 • Kalibrierungs- und Diagnoseprogramme • Abdeckung mit praktischen Gewichtsaufnahme-wannen • Autom. Aufnahme von Abstand und Raddurchmesser • 5 ALU Programme zum dynamischen Auswuchten mit Klebstoffengewichten • 3 statische Auswuchtprogramme (mit Federgewichten oder Klebstoffengewichten) • 2 spezielle Programme für Pax-Reifen mit mm Größe • Unwucht-Optimierungsprogramm • Bremspedal.

 • Auto étalonnage et auto diagnostique • Bac à plombs pratique • Mesure automatique du diamètre et de la distance de la roué • 5 programmes ALU pour équilibrage dynamique avec des masses adhésifs • 3 programmes pour équilibrage statique (avec masses à ressort ou masses adhésifs) • 2 programmes spéciaux pour les pneus Pax avec dimensions en mm • Programme optimisation équilibrage • pédale de freinage.

 • Autodiagnóstico y autocalibrado • Panel con prácticas cubetas para las contrapesas • Medición automática de diámetro y distancia de la rueda • 5 programas ALU para el equilibrio dinámico con pesos adhesivos • 3 programas de equilibrio estático (con pesos con resorte o con pesos adhesivos) • 2 programas especiales para neumáticos Pax con medidas en mm • Programa optimización desequilibrio • Pedal del freno.



Dati tecnici	Technical data	Technische Eigenschaften	Caractéristiques techniques	Datos técnico
Alimentazione standard monofase	Standard power supply single phase	Stromversorgung, einphasig	Alimentation standard mono	Alimentación estándar monofásica
Potenza max assorbita	Power draw	Leistungsaufnahme	Absorption	Potencia máx. absorbida
Larghezza cerchione	Rim width	Felgenbreite	Largeur jante	Anchura llanta
Diametro cerchione	Rim diameter	Felgendurchmesser	Diamètre jante	Diámetro llanta
Peso massimo ruota	Max. wheel weight	Max. Radgewicht	Poids maxi de la roue	Peso máximo rueda
Tempo di ciclo	Spin time	Dauer Messlauf	Temps de cycle	Tiempo de ciclo
Velocità di equilibratura	Balancing speed	Auswuchtgeschwindigkeit	Vitesse de rotation	Velocidad de equilibrado
Precisione di equilibratura	Balancing accuracy	Auswuchtgenauigkeit	Précision d'équilibrage	Precisión de equilibrado
Dimensioni	Dimensions	Abmessungen	Encombrement	Medidas
Dimensioni imballo	Packaging dimensions	Abmessungen, verpackt	Dimensions emballage	
Peso netto con accessori standard	Net weight with standard accessories	Nettogewicht mit Standardzubehör	Poids net avec accessoires standard	Peso neto con accesorios estándar
Peso lordo	Gross weight	Bruttogewicht	Poids brut	Peso bruto

Accessori standard
 Standard accessories
 Standard-Zubehör
 Accessoires standards
 Accesorios estándar



Flangia completa a coni
 Flange complete with cones
 Complettler Kegelflansch
 Plateau complet de cône
 Brida y cono para furgonetas



Peso campione da 100 gr / Pinza
 100g. sample weight / Pliers
 Mustergewicht Gewicht von 100 gr. / Zange
 Masse étalon du poids de 100 g. / Pince
 Peso muestra de 100 gr. / Tenazas



Calibro
 Gauge
 Compás
 Calibre
 Lehre

Opzioni
 Optionals
 Sonderzubehör
 Options
 Opciones



Distanziale, 4° cono, 5° cono
 4rd - 5th cone spacer
 Abstandstück, 4° Kegel, 5° Kegel
 Entretoise 4^{ème} cône, 5^{ème} cône
 Distanciadador, 4° cono, 5° cono



Flangia moto
 Motorcycle flange
 Motorradflansch
 Plateau moto
 Adaptador de moto



Flangia 3 -4 -5 fori
 3 -4 -5 hole flange
 Flansch mit 3 -4 -5 Bohrungen
 Plateau à 3 -4 -5 trous
 Adaptador 3 -4 -5 agujeros



GALAXY 1640

CE



 Equilibratrice elettronica, con schermo a colori, per equilibratura di ruote, moto e veicoli commerciali leggeri.



Computerized wheel balancer with colour monitor for cars, motorcycles and light commercial vehicles.



Rechnerunterstützte Reifenauswuchtmaschine mit Farbmonitor für PKW's, Motosräder und leichte Nutzfahrzeuge.



Equilibreuse à microprocesseur avec écran couleur pour roues voitures, motos et véhicules commerciaux légers.



Equilibradora electrónica con pantalla en color de para equilibrado de ruedas de turismos, motos y vehículos comerciales ligeros.



• Autodiagnosi e autotaratura • Pannello con pratiche vaschette portapesi • Rilevamento automatico diametro e distanza della ruota • 5 programmi ALU per l'equilibratura dinamica con pesi adesivi • 3 programmi di equilibratura statica (con pesi a molletta o adesivi) • 2 programmi speciali per pneumatici Pax con misure in mm • Funzione triplo operatore • Ottimizzazione squilibrio • Pedale freno



• Self-diagnosis and self calibration • User-friendly cover panel with weight holder • Automatic measurement of wheel diameter and distance • 5 programs ALU for dynamic balancing with adhesive weights • 3 programs for static balancing (with spring weights or adhesive weights) • 2 special programs for PAX tires with mm measure • Three-operators function • Unbalance optimization • Brake pedal



• Kalibrierungs- und Diagnoseprogramme • Abdeckung mit praktischen Gewichtsaufnahme-wannen • Autom. Aufnahme von Abstand und Raddurchmesser 5 ALU Programme zum dynamischen Auswuchten mit Klebstoffengewichten • 3 statische Auswuchtprogramme (mit Federgewichten oder Klebstoffengewichten) • 2 spezielle Programme für Pax-Reifen mit mm Größe • Dreifache Betreiber Funktion • Unwucht-Optimierungs-programm • Bremspedal



• Auto étalonnage et auto diagnostique • Bac à plombs pratique • Mesure automatique du diamètre et de la distance de la roue • 5 programmes ALU pour équilibrage dynamique avec des masses adhésifs • 3 programmes pour équilibrage statique (avec masses à ressort ou masses adhésifs) • 2 programmes spéciaux pour les pneus Pax avec dimensions en mm • Fonction triple opérateur • Programme d'optimisation • Pedal de freinage



• Autodiagnóstico y autocalibrado • Panel con prácticas cubetas para las contrapesas • Medición automática de diámetro y distancia de la rueda • 5 programas ALU para el equilibrio dinámico con pesos adhesivos • 3 programas de equilibrio estático (con pesos con resorte o con pesos adhesivos) • 2 programas especiales para neumáticos Pax con medidas en mm • Función triple operador • Optimización del desequilibrios • Pedal de freno

GALAXY 1640



Dati tecnici	Technical data	Technische Eigenschaften	Caractéristiques techniques	Datos técnico
Alimentazione standard monofase	Standard power supply single phase	Stromversorgung, einphasig	Alimentation standard mono	Alimentación estándar monofásica 230V 50 Hz
Potenza massima assorbita	Power draw	Leistungsaufnahme	Absorption	Potencia máxima absorbida 300 W
Larghezza cerchione	Rim width	Felgenbreite	Largeur jante	Anchura llanta 2" - 20" (50 - 510 mm)
Diametro impostabile	Rim diameter	Felgendurchmesser	Diamètre jante	Diámetro configurable 8" - 30"
Peso massimo ruota	Max. wheel weight	Max. Radgewicht	Poids maxi de la roue	Peso máximo rueda 70 Kg
Tempo di ciclo	Spin time	Dauer Messlauf	Temps de cycle	Tiempo de ciclo 13 sec.
Velocità di equilibratura	Balancing speed	Auswuchtgeschwindigkeit	Vitesse de rotation	Velocidad de equilibrado 170 rpm
Precisione di equilibratura	Balancing accuracy	Auswuchtgenauigkeit	Précision d'équilibrage	Precisión de equilibrado ± 1 gr
Dimensioni	Dimensions	Abmessungen	Encombrement	Medidas 1035x1009x1270 mm
Dimensioni imballo	Packaging dimensions	Abmessungen, verpackt	Dimensions emballage	Medidas embalaje 760x1070x1130 mm
Peso netto con accessori standard	Net weight with standard accessories	Nettogewicht mit Standardzubehör	Poids net avec accessoires standard	Peso neto con accesorios estándar 95 Kg
Peso lordo	Gross weight	Bruttogewicht	Poids brut	Peso bruto 113 Kg

Accessori standard
 Standard accessories
 Standard-Zubehör
 Accessoires standards
 Accesorios estándar



Flangia completa a coni
 Flange complete with cones
 Complettler Kegelflansch
 Plateau complet de cône
 Brida y cono para furgonetas

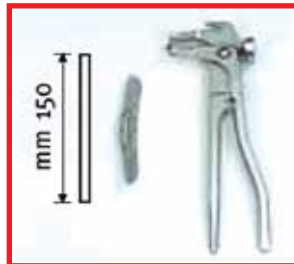

Peso campione da 100 gr / Pinza
 100g. sample weight / Pliers
 Mustergewicht Gewicht von 100 gr. / Zange
 Masse étalon du poids de 100 g. / Pince
 Peso muestra de 100 gr. / Tenazas



Calibro
 Gauge
 Compás
 Calibre
 Lehre

Opzioni
 Optionals
 Sonderzubehör
 Options
 Opciones



Distanziale, 4° cono, 5° cono
 4rd - 5th cone spacer
 Abstandstück, 4° Kegel, 5° Kegel
 Entretoise 4^{ème} cône, 5^{ème} cône
 Distanciadador, 4° cono, 5° cono



Flangia moto
 Motorcycle flange
 Motorradflansch
 Plateau moto
 Adaptador de moto



Flangia 3 -4 -5 fori
 3 -4 -5 hole flange
 Flansch mit 3 -4 -5 Bohrungen
 Plateau à 3 -4 -5 trous
 Adaptador 3 -4 -5 agujeros

The company reserves the right to introduce improvements in design or specification without prior notice



GALAXY 1680 - GALAXY 1680P

CE





 Equilibratrice elettronica, con schermo a colori, per equilibratura di ruote, moto e veicoli commerciali leggeri.

 **Computerized wheel balancer with colour monitor for cars, motorcycles and light commercial vehicles.**

 Rechnerunterstützte Reifen auswuchtmaschine mit Farbmonitor für PKW's, Motosräder und leichte Nutzfahrzeuge.

 Equilibreuse à microprocesseur avec écran couleur pour roues voitures, motos et véhicules commerciaux légers.

 Equilibradora electrónica con pantalla en color de para equilibrado de ruedas de turismos, motos y vehículos comerciales ligeros.

 • Autodiagnosi e autotaratura • Pannello con pratiche vaschette portapesi • Rilevamento automatico diametro e distanza della ruota • 5 programmi ALU per l'equilibratura dinamica con pesi adesivi • 3 programmi di equilibratura statica (con pesi a molletta o adesivi) • 2 programmi speciali per pneumatici Pax con misure in mm • Funzione triplo operatore • Ottimizzazione squilibrio • Pedale freno • Sensore laser per misura eccentricità (optional) • Dispositivo di bloccaggio ruota elettromeccanico (solo 1680P)

 • Self-diagnosis and self calibration • User-friendly cover panel with weight holder • Automatic measurement of wheel diameter and distance • 5 programs ALU for dynamic balancing with adhesive weights • 3 programs for static balancing (with spring weights or adhesive weights) • 2 special programs for PAX tires with mm measures • Three-operators function • Unbalance optimization • Brake pedal • Laser sensor measuring eccentricity (optional) • Electro-mechanical locking wheel device (for 1680P only).

 • Kalibrierungs- und Diagnoseprogramme • Abdeckung mit praktischen Gewichtsaufnahme-wannen • Autom. Aufnahme von Abstand und Raddurchmesser 5 ALU Programme zum dynamischen Auswuchten mit Klebstoffengewichten • 3 statische Auswuchtprogramme (mit Federgewichten oder Klebstoffengewichten) • 2 spezielle Programme für Pax-Reifen mit mm Größe • Dreifache Betreiber Funktion • Unwucht-Optimierungs-programm • Bremspedal • Laser-Sensor zum Messen der Exzentrizität (optional) • Sperrrad elektromechanische Geräte (nür für 1680P).

 • Auto étalonnage et auto diagnostique • Bac à plombs pratique • Mesure automatique du diamètre et de la distance de la roué • 5 programmes ALU pour équilibrage dynamique avec des masses adhésifs • 3 programmes pour équilibrage statique (avec masses à ressort ou masses adhésifs) • 2 programmes spéciaux pour les pneus Pax avec dimensions en mm • Fonction triple operateur • Programme d'optimisation • Pedal de freinage • Capteur laser pour mesure excentricité (optional) • Dispositif électromécanique de verrouillage roue (pour 1680P seulement).

 • Autodiagnóstico y autocalibrado • Panel con prácticas cubetas para las contrapesas • Medición automática de diámetro y distancia de la rueda • 5 programas ALU para el equilibrio dinámico con pesos adhesivos • 3 programas de equilibrio estático (con pesos con resorte o con pesos adhesivos) • 2 programas especiales para neumáticos Pax con medidas en mm • Función triple operatör • Optimización del desequilibrios • Pedal de freno • Sensör laser por medida excentricidad (opcionál) • Dispositivo de bloqueo ruedas electromecánico (solo para 1680P)

GALAXY 1680 - GALAXY 1680P



Dati tecnici	Technical data	Technische Eigenschaften	Caractéristiques techniques	Datos técnico
Alimentazione Motoinverter	Power supply Motoinverter	Stromversorgung, Motoinverter	Alimentation Motoinverter	Alimentación Motoinverter
Potenza massima assorbita	Power draw	Leistungsaufnahme	Absorption	Potencia máxima absorbida
Larghezza cerchione	Rim width	Felgenbreite	Largeur jante	Anchura llanta
Diametro impostabile	Rim diameter	Felgendurchmesser	Diamètre jante	Diámetro configurable
Peso massimo ruota	Max. wheel weight	Max. Radgewicht	Poids maxi de la roue	Peso máximo rueda
Tempo di ciclo	Spin time	Dauer Messlauf	Temps de cycle	Tiempo de ciclo
Velocità di equilibratura	Balancing speed	Auswuchtgeschwindigkeit	Vitesse de rotation	Velocidad de equilibrado
Precisione di equilibratura	Balancing accuracy	Auswuchtgenauigkeit	Précision d'équilibrage	Precisión de equilibrado
Dimensioni	Dimensions	Abmessungen	Encombrement	Medidas
Dimensioni imballo	Packaging dimensions	Abmessungen, verpackt	Dimensions emballage	Medidas embalaje
Peso netto con accessori standard	Net weight with standard accessories	Nettogewicht mit Standardzubehör	Poids net avec accessoires standard	Peso neto con accesorios estándar
Peso lordo	Gross weight	Bruttogewicht	Poids brut	Peso bruto

Accessori standard
 Standard accessories
 Standard-Zubehör
 Accessoires standards
 Accesorios estándar



Flangia completa a coni
 Flange complete with cones
 Completer Kegelflansch
 Plateau complet de cône
 Brida y cono para furgonetas



Peso campione da 100 gr / Pinza
 100g. sample weight / Pliers
 Mustergewicht Gewicht von 100 gr. / Zange
 Masse étalon du poids de 100 g. / Pince
 Peso muestra de 100 gr. / Tenazas



Calibro
 Gauge
 Compás
 Calibre
 Lehre

Opzioni
 Optionals
 Sonderzubehör
 Options
 Opciones



Distanziale, 4° cono, 5° cono
 4rd - 5th cone spacer
 Abstandstück, 4° Kegel, 5° Kegel
 Entretoise 4^{ème} cône, 5^{ème} cône
 Distanciadador, 4° cono, 5° cono



Flangia moto
 Motorcycle flange
 Motorradflansch
 Plateau moto
 Adaptador de moto



Flangia 3 -4 -5 fori
 3 - 4 - 5 hole flange
 Flansch mit 3 -4 -5 Bohrungen
 Plateau à 3 -4 -5 trous
 Adaptador 3 -4 -5 agujeros

The company reserves the right to introduce improvements in design or specification without prior notice





GALAXY 1690

CE





 Equilibratrice elettronica per vetture, autobus e camion con sollevatore pneumatico ruota.

 **Computerized electronic wheel balancer for cars coaches and trucks with pneumatic wheel lift.**

 Rechnerunterstützte Reifenauswuchtmaschine für LKW, PKW und Busse; mit pneumatischem Radheber.

 Equilibreuse à microprocesseur pour roues voitures, tourisme et poids lourds avec élévateur pneumatique roues.

 Equilibradora electrónica para turismos, autobuses y camiones con elevador neumático de la rueda.

 • Autotaratura con qualsiasi ruota • Pannello con pratiche vaschette portapesi • Funzioni 'Alu' e 'Alu S' • Leva freno • Sollevatore pneumatico ruota

 • Self calibration with any kind of wheel • User-friendly cover panel with weight trays • Brake lever • ALU and ALU S functions • Pneumatic wheel lift

 • Kalibrierungsprogramm • Abdeckung mit praktischen Gewicht-saufnahmewannen • Bremshebel • ALU und ALU S-Funktionen • Pneumatischer Radheber

 • Auto étalonnage • Bac à plombs pratique • Levier frein • Fonctions 'Alu' et 'Alu S' • Élévateur pneumatique roues

 • Autocalibrado con cualquier rueda • Panel con prácticas cubetas para las contrapesas • Funciones 'Alu' y 'Alu S' • Palanca de freno • Elevador neumático de rueda



Dati tecnici	Technical data	Technische Eigenschaften	Caractéristiques techniques	Datos técnico
Alimentazione standard monofase	Standard power supply single phase	Stromversorgung, einphasig	Alimentation standard mono	Alimentación estándar monofásica
Potenza massima assorbita	Power draw	Leistungsaufnahme	Absorption	Potencia máxima absorbida
Larghezza cerchione	Rim width	Felgenbreite	Largeur jante	Anchura llanta
Diametro impostabile	Rim diameter	Felgendurchmesser	Diamètre jante	Diámetro configurable
Peso massimo ruota	Max. wheel weight	Max. Radgewicht	Poids maxi de la roue	Peso máximo rueda
Tempo di ciclo	Spin time	Dauer Messlauf	Temps de cycle	Tiempo de ciclo
Precisione di equilibratura	Balancing accuracy	Auswuchtgenauigkeit	Précision d'équilibrage	Precisión de equilibrado
Dimensioni	Dimensions	Abmessungen	Encombrement	Medidas
Peso netto con accessori standard	Net weight with standard accessories	Nettogewicht mit Standardzubehör	Poids net avec accessoires standard	Peso neto con accesorios estándar
Peso lordo	Gross weight	Bruttogewicht	Poids brut	Peso bruto

Accessori standard
 Standard accessories
 Standard-Zubehör
 Accessoires standards
 Accesorios estándar



Flangia completa a coni
 Flange complete with cones
 Completer Kegelflansch
 Plateau complet de cône
 Brida y cono para furgonetas



Kit per trasporto leggero SUV
 Light transport and SUV Kit
 Set fuer PKV und SUV
 Jeu pour voiture et SUV
 Juego para turismos y SUV



Kit per camion e bus
 Truck and bus kit
 Set fuer LKW und Busse
 Jeu pour camion et tourisme
 Juego para camiones y buses

Opzioni
 Optionals
 Sonderzubehör
 Options
 Opciones



Flangia moto
 Motorcycle flange
 Motorradflansch
 Plateau moto
 Adaptador de moto



Flangia 3 -4 -5 fori
 3 -4 -5 hole flange
 Flansch mit 3 -4 -5 Bohrungen
 Plateau à 3 -4 -5 trous
 Adaptador 3 -4 -5 agujeros



SEROS 3000C - SEROS 3000BT

CE

SEROS 3000C

Versione via cavo
Cable data transmission
Datenübertragung mittels Kabel
Version avec cable
Versión por cable

SEROS 3000BT

Versione bluetooth
Bluetooth version
Bluetooth Version
Version Bluetooth
Versión bluetooth





 Apparecchiatura per assetto ruote autovetture e veicoli commerciali leggeri.

 **Wheel aligner for cars and light commercial vehicles.**

 Achsmessgerät für PKW und leichte Nutzfahrzeuge.

 Contrôleur de géométrie pour voitures et fourgons.

 Equipo para alineación de ruedas de turismos y vehículos comerciales ligeros.

 • Sistema basato su Windows XP • Display LCD 17" • Sistema a 8 camere ccd • 4 rilevatori di peso e ingombro ridotto con comandi integrati • Banca dati con oltre 15000 schede tecniche veicolo già inserite e possibilità di ulteriore inserimento di schede da parte dell'utilizzatore. Aggiornamenti periodici disponibili. • Banca dati clienti per la registrazione di infiniti interventi con ricerca per nominativo o numero di targa veicolo

 • Operating system based on Windows XP • 17" LCD Display • 8 ccd sensors • 4 sensors with reduced weight and reduced dimensions, with integrated controls • Data bank with more than 15000 vehicles listed. User can enter manually data of any required vehicle. Data bank can be updated periodically • Customer data bank allows to store an infinite number of mainenance jobs with search function that works either with customer name or vehicle number plate

 • Betriebssystem basiert auf Windows XP • 17"-LCD-Bildschirm • 8 CCD Messköpfe • 4 kompakte, leichte Messköpfe mit integriertem Bedienteil • Fahrzeug Datenbank mit über 15.000 gelisteten Fahrzeugen. Manuelle Dateneingabe von neuen/anderen Fahrzeugtypen unbeschränkt möglich. Datenbank Nachträge werden periodisch z. Verfügung gestellt. • Die Kunden-Datenbank erlaubt die Speicherung einer unendlichen Anzahl Wartungseingriffe mit einer Suchfunktion, deren Suchkriterium entweder der Kundennamenname oder das amtliche Knzeichen ist

 • Système d'exploitation basé sur Windows XP • Écran LCD 17" • Système avec 8 capteurs CCD • 4 têtes de mesure légères et compactes avec commandes intégrés • Banque de données avec plus de 15.000 types de véhicules. Possibilité d'introduire manuellement fiches données sans limite. Mise à jour périodique de la banque données disponible. • Banque des données clients qui permet la mémorisation d'une quantité infinie de travaux d'entretien et dont la recherche peut être faite par nom du client ou par la plaque du véhicule

 • Sistema basado en Windows XP • Pantalla LCD 17" • Sistema de 8 cámaras CCD • 4 captore de peso de dimensiones reducidas con mandos integrados • Banco de datos con más de 15000 fichas de vehículo ya introducidas y posibilidad de ulterior introducción de fichas por parte del usuario. Disponibles actualizaciones periódicas. • Banco de datos de clientes para registrar infinitas actuaciones con búsqueda por nombre o por número de matrícula del vehículo

SEROS 3000C - SEROS 3000BT



Dati tecnici	Technical data	Technische Eigenschaften	Caractéristiques techniques	Datos técnico		
Angoli misurabili	Measurable angles	Messbare Winkel	Angles mesurés	Ángulos medibles	Tolleranza/Campo di Misura Tolerance/Measuring field Toleranz/Messfeld Tolerance/Champ de mesure Tolerancia/Campo de medición	Campo Totale di Misura (su sterzata max) Total measuring field (at max. steering angle) Gesamt Messfeld (auf max. Lenkeinschlag gemessen) Champs de mesure total (à braquage max.) Campo total de medición (con viraje máx.)
ASSE POSTERIORE	FRONT AXLE	VORDERACHSE	ESSIEUX AVANT	EJE TRASERO		
convergenza	total toe	Spur total	Parallélisme total	convergenzia	±2' ±4°	±22°
semiconvergenza	partial toe	Spur Einzelräder	Parallélisme roue par roue	convergenzia ruota por ruota	±2' ±4°	±22°
deviazione asse	set-back	Achsversatz	Décalage essieu	desvío eje	±3' ±4°	±22°
inclinazione asse	camber	Achsneigung	Inclinaison du pivot	inclinación eje	±3' ±6°	±22°
incidenza montante	caster	Nachlaufwinkel	Carrossage	incidencia montante	±9'	±18°
inclinazione montante	king pin	Sturz	Chasse	inclinación montante	±9'	±18°
angolo incluso	included angle	Lenkrollradius	Angolo inclus	ángulo incluido	-	-
sterzata interna	inner steering	Lenkeinschlag innen	Braquage intérieur	viraje interno	-	-
sterzata esterna	outer steering	Lenkeinschlag aussen	Braquage extérieur	viraje esterno	-	-
simmetria di sterzata a 20°	20° steering symmetry	Spurdifferenz	Divergence de braquage	simetria de viraje a 20°	-	-
ASSE ANTERIORE	REAR AXLE	HINTERACHSE	ESSIEU ARRIERE	EJE DELANTERO		
convergenza	total toe	Spur total	Parallélisme total	convergenzia	±2' ±4°	±22°
semiconvergenza	partial toe	Spur Einzelräder	Parallélisme roue par roue	convergenzia ruota por ruota	±2' ±4°	±22°
deviazione asse	set-back	Achsversatz	Décalage essieu	desvío eje	±3' ±4°	±22°
inclinazione ruota	camber	Achsneigung	Inclinaison du pivot	inclinación ruota	±3' ±6°	±22°
angolo di spinta	thrust line	Spurdifferenzwinkel	Angle de poussée	ángulo de empuje	-	-
Alimentazione consolle	Power supply of control panel	Stromversorgung Steuertafel	Alimentation consolle	Alimentación pupitre		1ph 230V 50/60 Hz
Potenza assorbita	Power input	Aufgenommene Leistung	Puissance	Potencia absorbida		300 W
Alimentazione rilevatori	Power supply of sensors	Stromversorgung Messköpfe	Alimentation têtes	Alimentación captores		1 battery pack 7.2V 1.4 Ah
Dimensioni	Dimensions	Abmessungen	Dimensions	Medidas		1.120 x 1.610 x 840 mm
Peso	Weight	Gewicht	Poids	Peso		~150 Kg.



4 rilevatori
4 sensors
4 Messköpfe
4 têtes
4 captores



4 aggrappi a 4 punti da 12" a 21"
4 pcs. 4 point wheel clamps 12" to 21"
4 Stk. 4 PunktRadklammern von 12" bis 21"
4 pc. griffes à 4 points de 12" à 21"
4 garras de 4 puntos de 12" a 21"

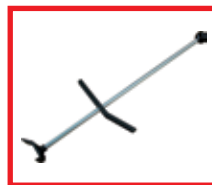

Bloccafreno
Brake pedal locker
Bremspedalfeststeller
Presse pédale du frein
Bloqueo freno



Bloccasterzo
Steering wheel locker
Lenkradhalter
Bloque volant
Bloqueo dirección



Kit 2 piatti rotanti
Kit (2) radius plates
Satz (2) Drehteller
Jeu (2) de plateaux pivotants
Kit 2 platos giratorios



Opzioni



Optionals



Sonderzubehör



Options



Opciones

Optional per aggrappi a 4 punti
- Gruppo bloccaggio rapido a molla
- Kit griffe sagomate (4)
- Kit griffe sagomate 30° (4)

Aggrappo 9"-21" a 3 punte con bloccaggio rapido a molla

Optional per aggrappi a 3 punti
- Kit griffe per furgoni (3)
- Kit griffe sagomate (3)
- Kit griffe sagomate 30° (3)
- Kit prolunghe 58mm (3)

Barra taratura rilevatori

Kit aggiornamento banca dati veicoli

Options for 4 point wheel clamps
- Spring loaded quick clamping system
- Moulded wheel clamp kit (4)
- 30° Moulded wheel clamp kit (4)

3 Point wheel clamp with spring loaded quick clamping system 9"-21"

Options for 3 point wheel clamps
- Wheel clamp kit for light commercial vehicles (3)
- Moulded wheel clamp kit (3)
- 30° Moulded wheel clamp kit (3)
- Extension kit 58mm (3)

Sensor calibration bar

Databank upgrading kit

Zubehör für 4 Punkt Radklammern
- Federgespannte Schnell Radklemme
- Satz (4) profilierte Radklemmen
- Satz (4) profilierte 30° Radklemmen

3 Punkt Radklemme 9" bis 21" mit federgespannter Schnellspannvorrichtung

Zubehör für 3 Punkt Radklammern
- Satz Radklammern f. leichte Nutzfahrzeuge (3)
- Satz (3) profilierte Radklemmen
- Satz (3) profilierte 30° Radklemmen
- Verlängerungs Satz 58 mm (3)

Messkopf Kalibrierbalken

Datenbank Nachtragsset

Options pour griffes à 4 points
- Blocage rapide à ressort
- Jeu de griffes (4) profilées
- Jeu de griffes (4) profilées 30°

Griffe à 3 points de 9" à 21" avec blocage rapide à ressort

Options pour griffes à 3 points
- Jeu de griffes pour fourgons (3)
- Jeu de griffes (3) profilées
- Jeu de griffes (3) profilées 30°
- Jeu extensions 58 mm (3)

Barre d'étalonnage des têtes

Kit de mise à jour de la banque de données

Opción para garras de 4 puntos
- Grupo bloqueo rápido con resorte
- Kit garras perfiladas (4)
- Kit garras perfiladas 30° (4)

Grapa 9"-21" con 3 puntas con bloqueo rápido por resorte

Opción para garras de 3 puntos
- Kit garras para furgonetas (3)
- Kit garras perfiladas (3)
- Kit garras perfiladas 30° (3)
- Kit prolongaciones 58 mm (3)

Barra calibrado captores

Kit actualización banco de datos de vehículos

The company reserves the right to introduce improvements in design or specification without prior notice





SEROS 3000BT Truck - 3000BT Truck 4

CE

SEROS
3000BT Truck





 Apparecchiatura per assetto ruote veicoli industriali e autobus con rilevatori bluetooth.

 **Wheel aligner for trucks and coaches with bluetooth-sensors.**

 Achsmessgerät für LKW und Reisebusse mit Bluetooth.

 Contrôleur de géométrie pour poids lourds et autocars avec capteurs bluetooth.

 Equipo para alineación de ruedas de vehículos industriales y autobuses con captores bluetooth.

 • Sistema basato su Windows XP • Display LCD 17" • Sistema a 4 camere ccd + 2 ripetitori (3000BT Truck) • 2 rilevatori di peso e ingombro ridotto con comandi integrati (3000BT Truck) • 4 rilevatori di peso e ingombro ridotto con comandi integrati (3000BT Truck 4) • Banca dati veicoli con possibilità di integrazione manuale e aggiornabile periodicamente • Banca dati clienti per la registrazione di infiniti interventi con ricerca per nominativo o numero di targa veicolo

 • Operating system based on Windows XP • 17"-LCD-Display • 4 ccd sensors + 2 signal amplifiers (3000BT Truck) • 2 sensors detect reduced weight and reduced dimensions, with integrated controls (3000BT Truck) • 4 sensors detect reduced weight and reduced dimensions, with integrated controls (3000BT Truck 4) • Vehicle data bank; data can be entered manually and is periodically upgradable • Customer data bank allows to store an infinite number of maintenance jobs with search function that works either with customer name or vehicle number plate

 • Betriebssystem basiert auf Windows XP • 17"-LCD-Bildschirm • 4 CCD Messköpfe + 2 Signalverstärker (3000BT Truck) • 2 kompakte, leichte Messköpfe mit integriertem Bedienteil (3000BT Truck) • 4 kompakte, leichte Messköpfe mit integriertem Bedienteil (3000BT Truck 4) • Fahrzeug-Datenbank. Manuelle Dateneingabe und periodische Nachträge möglich • Die Kunden-Datenbank erlaubt die Speicherung einer unendlichen Anzahl Wartungseingriffe mit einer Suchfunktion, deren Suchkriterium entweder der Kundennamenname oder das amtliche Knzeichen ist

 • Système d'exploitation basé sur Windows XP • Écran LCD 17" • Système avec 4 capteurs CCD + 2 répéteurs (3000BT Truck) • 2 têtes de mesure légères et compactes avec commandes intégrés (3000BT Truck) • 4 têtes de mesure légères et compactes avec commandes intégrés (3000BT Truck 4) • Banque de données Constructeurs complète avec possibilité de entrée de données et mise à jour périodique • Banque des données clients qui permet la mémorisation d'une quantité infinie de travaux d'entretien et dont la recherche peut être faite par nom du client ou par la plaque du véhicule

 • Sistema basado en Windows XP • Pantalla LCD 17" • Sistema de 4 cámaras CCD + 2 repetidores (3000BT Truck) • 2 captore de peso de dimensiones reducidas con mandos integrados (3000BT Truck) • 4 captore de peso de dimensiones reducidas con mandos integrados (3000BT Truck 4) • Banco de datos de vehículos con la posibilidad de integración manual y actualizable periódicamente • Banco de datos de clientes para registrar infinitas actuaciones con búsqueda por nombre o por número de matrícula del vehículo



Dati tecnici	Technical data	Technische Eigenschaften	Caractéristiques techniques	Datos técnico		
Angoli misurabili	Measurable angles	Messbare Winkel	Angles mesurés	Ángulos medibles	Tolleranza/Campo di Misura Tolerance/Measuring field Toleranz/Messfeld Tolerance/Champ de mesure Tolerancia/Campo de medición	Campo Totale di Misura (su sterzata max) Total measuring field (at max. steering angle) Gesamt Messfeld (auf max. Lenkeinschlag gemessen) Champs de mesure total (à braquage max.) Campo total de medición (con viraje máx.)
ASSE ANTERIORE	REAR AXLE	HINTERACHSE	ESSIEU ARRIERE	EJE DELANTERO		
convergenza	total toe	Spur total	Parallélisme total	convergenzia	±2' ±4°	±22°
semiconvergenza	partial toe	Spur Einzelräder	Parallélisme roue par roue	convergenzia ruota por ruota	±2' ±4°	±22°
deviazione asse	set-back	Achsversatz	Décalage essieu	desvío eje	±3' ±4°	±22°
inclinazione asse	camber	Achsneigung	Inclinaison du pivot	inclinación eje	±3' ±6°	±22°
incidenza montante	caster	Nachlaufwinkel	Carrossage	incidencia montante	±9'	±18°
inclinazione montante	king pin	Sturz	Chasse	inclinación montante	±9'	±18°
angolo incluso	included angle	Lenkrollradius	Angolo inclus	ángulo incluido	-	-
sterzata interna	inner steering	Lenkeinschlag innen	Braquage intérieur	viraje interno	-	-
sterzata esterna	outer steering	Lenkeinschlag aussen	Braquage extérieur	viraje esterno	-	-
simmetria di sterzata a 20°	steering symmetry	Spurdifferenz	Divergence de braquage	simetría de viraje a 20°	-	-
Alimentazione consolle	Power supply of control panel	Stromversorgung Steuertafel		Alimentación consolle	Alimentación pupitre	1ph 230V 50/60 Hz
Potenza assorbita	Power input	Aufgenommene Leistung		Puissance	Potencia absorbida	300 W
Alimentazione rilevatori	Power supply of sensors	Stromversorgung Messköpfe		Alimentation têtes	Alimentación captores	1 battery pack 7.2V ≈ 1.4 Ah
Dimensioni	Dimensions	Abmessungen		Dimensions	Medidas	1.120 x 1.610 x 840 mm
Peso	Weight	Gewicht		Poids	Peso	~170 Kg.



3000BT Truck
2 rilevatori
2 sensors
2 Messköpfe
2 têtes
2 captores

3000BT Truck 4
4 rilevatori
4 sensors
4 Messköpfe
4 têtes
4 captores



3000BT Truck
2 ripetitori
2 repeaters
2 Signalverstärker
2 répéteurs de signal
2 repetidores



3000BT Truck
2 aggrappi a 4 punti da 10" a 26"
2 4-point wheel clamps (10" a 26")
2 4-Punkt-Radklammern von 10" bis 26"
2 griffes à 4 points de 10" à 26"
2 garras de 4 punti de 10" a 26"

Opzioni

Optionals

Sonderzubehör

Options

Opciones

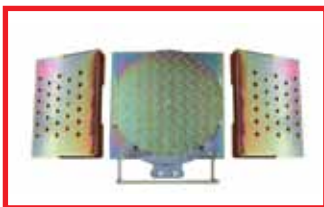

V1601
Kit 2 piatti rotanti + rampe per piatti rotanti
Radius plates (2 pcs.) + Radius plates ramps
2 Mechanische drehteller + halter f. Drehteller
Jeu de 2 plateaux pivotants + supports pour plateaux pivotants
Kit 2 platos giratorios + rampas para platos giratorios

V1004
Barra taratura rilevatori
Sensor calibration bar
Messkopf-Kalibrierbalken
Barre d'étalonnage des têtes
Barra calibrado captores

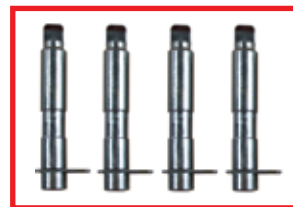

V1045
Kit griffe per furgoni 98mm (4)
Kit of (4) wheel clamps for commercial vehicles, 98mm
Satz radklammern f. Leichte nutzfahrzeuge, 98mm (4)
Jeu de 4 griffes pour fourgons 98mm
Kit garras para furgonetas 98 mm (4)



Kit aggiornamento banca dati veicoli
Databank upgrading kit
Datenbank-Nachtragsset
Kit de mise à jour de la banque de données
Kit actualización banco de datos de vehículos

W
E
R
T
H
E
R

W E R T H E R I N T E R N A T I O N A L S . p . A .



www.wertherint.com